



Model
TRO24T4XYZ1



Description

The TRO24T4XYZ1 is a combination controller and thermostat. The VAV Thermostat Controller is designed for simple and accurate control of any variable air volume box in a number of zone control configurations. Its field configurable algorithms enable versatile implementation of required control sequences.

Applications

- Cooling only with or without terminal reheat
- Heating/cooling with or without auto-changeover and terminal reheat
- Pressure dependent or pressure independent
- Single duct or dual duct
- Serial or parallel fan power boxes (on/off or ECM)
- Supply and exhaust applications
- Auxiliary heating sources, such as electric baseboards, can also be applied

Features

- Backlit LCD with simple icon and text driven menus
- Configurable inputs and outputs
- Precise temperature control with programmable PI function
- Selectable Fahrenheit or Celsius scale
- Manual night set back override
- Multi level lockable access menu and setpoint
- Selectable internal or external temperature sensor (10 KΩ)
- Changeover by contact or external temperature sensor
- Pressure sensor input with air flow program
- Selectable proportional control band and dead band
- Anti-freeze protection



TRO24T4XYZ1

Typical Application

VAV applications incorporate a central unit that delivers a controlled volume of air, which can be cooled or heated, to multiple zones. Each zone incorporates a VAV control box with a motorized damper to adjust the flow of air to the controlled zone based on the demand. Some configurations include one or more of the following: air flow pressure sensor, fan, duct heater, duct temperature sensor, and auxiliary heat (e.g. baseboard).

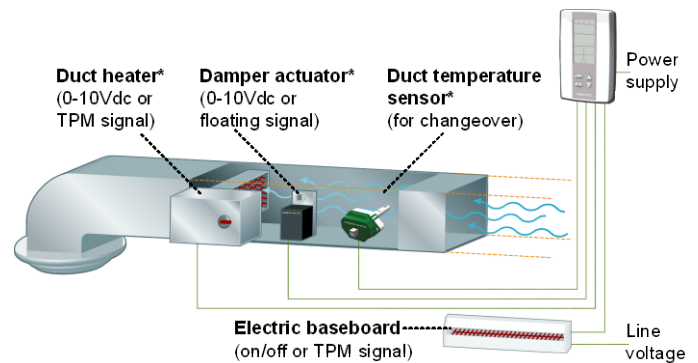

* Consult www.neptronic.com for details on these Neptronic products.

Technical Specifications

Description	TRO24T4XYZ1
Inputs	3 Universal analog inputs: 0-10Vdc, Thermistor (10k Type 3), or digital input (dry contact) Available for sensors: external temperature, changeover, night set back or pressure
Outputs	2 Analog outputs: 0-10Vdc or 2-10Vdc selectable (2mA max.) 4 TRIAC outputs: on/off, pulse 0 or 24Vac (250 mA max.), or 2 floating outputs
Power supply	22 to 26Vac 50/60Hz
Power consumption	1VA
Setpoint range	10°C to 40°C [50°F to 104°F]
External sensor range	-40°C to 100°C [-40°F to 212°F]
Control accuracy	Temperature: ±0.4°C [0.8°F]
Proportional band	0.5°C to 5°C [1°F to 10°F] adjustable
Electrical connection	0.8 mm ² [18 AWG] minimum
Operating temperature	0°C to 50°C [32°F to 122°F]
Storage temperature	-30°C to 50°C [-22°F to 122°F]
Relative Humidity	5 to 95% non condensing
Degree of protection of housing	IP 30 (EN 60529)
Weight	160 g. [0.36 lb]



Description	TRO24T4XYZ1
Dimensions A = 2.85" 73mm B = 4.85" 123mm C = 1.00" 24mm D = 2.36" 60mm E = 3.27" 83mm	

Wiring

We strongly recommend that all Neptronic products be wired to a separate grounded transformer and that transformer shall service only Neptronic products. This precaution will prevent interference with, and/or possible damage to incompatible equipment.

Terminal Description		Details
1	Common	
2	Common	
3	Common	
4	24 Vac	
5	24 Vac	
6	TRIAC output 1 (TO1)	Floating 1 (applies to pins 6-8 if set to "FLT" at step 8) TO1 = close TO2= open
7	External 24 Vac for TO1 & TO2 (if JP2 set to B&C)	
8	TRIAC output 2 (TO2)	Floating 2 (applies to pins 9-11 if set to "FLT" at step 16) TO3 = close TO4= open
9	TRIAC output 3 (TO3)	
10	External 24 Vac for TO3 & TO4 (if JP1 set to B&C)	
11	TRIAC output 4 (TO4)	
12	Analog input 1 (AI1)	see step 32 and DIP switch (DS2 – 1&2)
13	Analog input 2 (AI2)	see step 33 and DIP switch (DS2 – 3&4)
14	Analog input 3 (AI3)	see step 34 and DIP switch (DS2 – 5&6)
15	Analog output 1 (AO1)	see step 24
16	Analog output 2 (AO2)	see step 25

Jumpers

Jumpers		Description
JP1	Output Signal Selector TO3 and TO4	A&B = Internal: TRIAC output signal is linked to internal 24 Vac (same as thermostat) B&C = External: TRIAC output signal is linked to external 24 Vac (different than thermostat)
JP2	Output Signal Selector TO1 and TO2	

DS1 - Mode Selector

DIP Switches		ON	OFF
1	Mode	Programming Mode	Operation Mode
2	Not used	-	-
3	Not used	-	-

DS2 – Analog Input Type

Description	AI1 (step 32)		AI2 (step 33)		AI3 (step 34)	
	1	2	3	4	5	6
Thermistor 10kΩ / dry contact	ON	OFF	ON	OFF	ON	OFF
Analog 0-10Vdc (only if input set to "PRSD" or "PRSA")	OFF	ON	OFF	ON	OFF	ON



Mounting Instructions

⚠ CAUTION: Remove power to avoid a risk of malfunction.

- A. Remove the captive screw that's holding the base and the front cover of the unit together.
- B. Lift the front cover of the unit to separate it from the base.
- C. Pull all wires through the holes in the base.
- D. Secure the base to the wall using wall anchors and screws (supplied). Make the appropriate connections.
- E. Mount the control module on the base and secure using the screw.

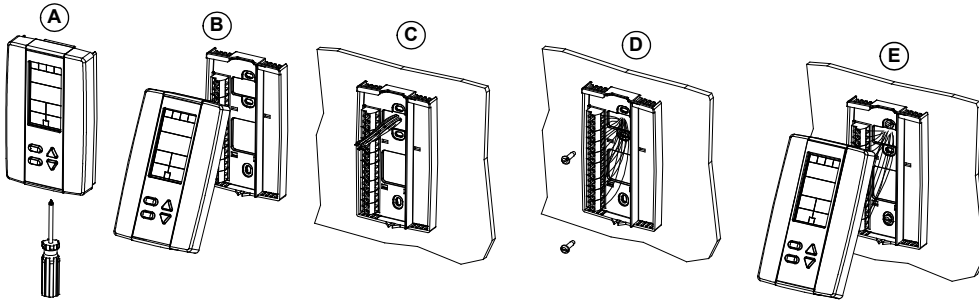

Programming Mode

i The Mode Selector DIP switch (DS1) must be set to the "ON" position (Programming Mode). Refer to Wiring on page 2. To exit, set DIP switch back to the "OFF" position (Operation Mode). All changes will be saved.

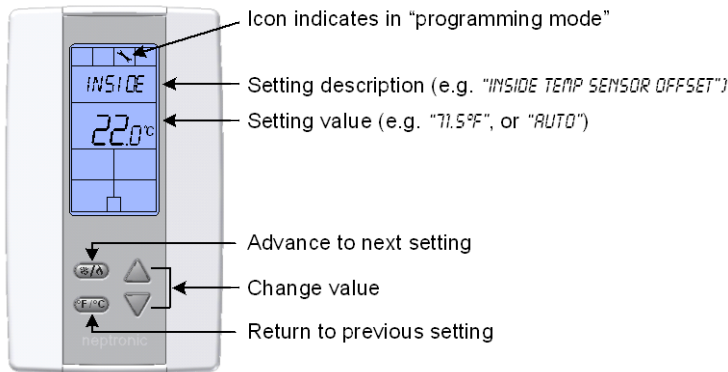

Symbols used in this Manual

	Single Duct
	Temperature
	Heating
	Cooling
	TRIAC Output 1
	TRIAC Output 2
	TRIAC Output 3
	TRIAC Output 4

	Analog Output 1
	Analog Output 2
	Analog Input 1
	Analog Input 2
	Analog Input 3
	Air Flow
	Night Set Back
	Timer/Clock



Setpoint and User Control

1. "INSIDE TEMP SENSOR OFFSET"



Range:	10 to 40°C	[50 to 104°F]
Offset:	Max. ± 5°C	
Increment:	0.1°C	[0.2°F]

Compare the displayed temperature reading with a known value from a thermometer. To offset or calibrate the sensor, use the arrows key to set the desired temperature reading. This is useful for thermostats installed in areas where the temperature read is slightly different than the room's actual temperature. For example, a thermostat placed right under the air diffuser. If the thermostat is set to use an external temperature sensor (EtS at Step 32, 33 or 34), the thermostat displays "OFF".

2. "ADJUST MINIMUM USER SETPNT"



Default:	15°C	[59°F]
Range:	10 to 40°C	[50 to 104°F]
Increment:	0.5°C	[1.0°F]

In Operation mode, you cannot decrease the setpoint to less than the value set as the minimum user point. The minimum value is restricted by the maximum value set in Step 3. In other words, the value that is set as the minimum cannot be greater than the maximum value.

3. "ADJUST MAXIMUM USER SETPNT"



Default:	30°C	[86°F]
Range:	10 to 40°C	[50 to 104°F]
Increment:	0.5°C	[1.0°F]

In Operation mode, you cannot increase the setpoint to more than the value set as the maximum user point. The maximum value is restricted by the minimum value set in Step 2. In other words, the value that is set as the maximum cannot be less than the minimum value.

4. "USER SETPNT LOCKED"



Default:	No (Unlocked)
Range:	Yes / No

If set to No, the user setpoint option is not locked and the user can adjust the desired setpoint temperature. If set to Yes, the user setpoint option is locked and the user cannot set the desired setpoint temperature. A lock symbol  appears, to indicate that the setpoint is locked.

5. "ADJUST INTERN SETPNT"



Default:	22°C	[72°F]
Range:	10 to 40°C	[50 to 104°F]
Increment:	0.5°C	[1.0°F]

Set the desired temperature setpoint within the defined range. If the setpoint option was locked in Step 4, a lock symbol  is displayed. The setpoint value is restricted by the minimum (Step 2) and maximum (Step 3) values. In other words, the setpoint should be within in the minimum and maximum setpoint range.

6. "ADJUST TEMPER CONTROL MODE"



Default:	Auto (Automatic)
Range:	Auto (Automatic), On (Cooling or Heating), Heat (Heating Only), Cool (Cooling Only)

Select the control mode that you want to authorize to the user. To authorize all the available modes, select Auto (Automatic Mode).

7. "ENABLE ON OFF CONTROL MODE"



Default:	Yes (Enable)
Range:	Yes / No

If you select Yes, the user can set the unit to "Off" via the Control Mode (see page 14). If you select No, the "Off" selection does not appear in the Control Mode.



TRIAC Output 1 (TO1)

8. "SELECT TO1 OUTPUT SIGNAL"

TO1 Default: FLt (floating)
Range: FLt (floating), OnOf (on/off), PULs (pulsed)

Select the desired signal from the available options.

- If you select FLt, ramp TO1 will be used for TO2. TO1 ramp will be set to close and TO2 will be set to open.
- If you select PULs, only the Heating 1 and Heating 2 ramps will be available at Step 9.

9. "SELECT TO1 SIGNAL RAMP"

TO1 Default: Cr1 (Cooling ramp 1)
Range: Cr1, Cr2, Hr1, Hr2, COr, OFF

Select the desired ramp from the available options.

- If you selected FLt at Step 8, ramp TO1 will be used for TO2. TO1 ramp will be set to close and TO2 will be set to open.
- If you selected PULs at Step 8, only Heating Ramp 1 and Heating Ramp 2 will be available.

If you selected OnOf at Step 8, go to Step 12.

If you selected PULs at Step 8, or OFF at this step, go to Step 13.

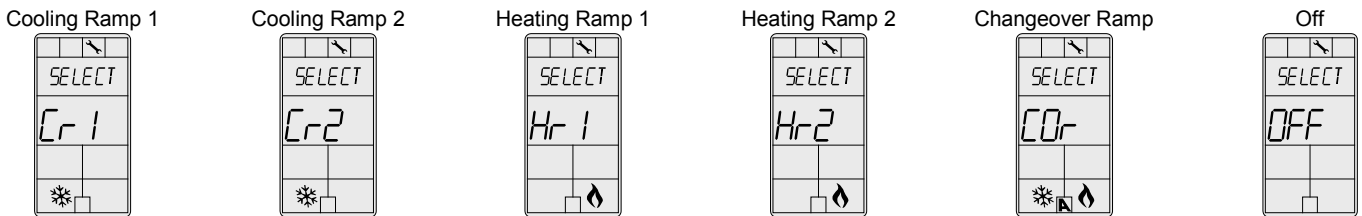

10. "SET FLOATING TIME IN SECONDS"

TO1 Default: 100 seconds
Range: 15 to 250 seconds
Increment: 5 seconds

This option appears only if you selected FLt (Floating) at Step 8. Set the desired value for floating time signal.

11. "SELECT MOTOR DIRECT REVERSE"

TO1 Default: Dir (Direct)
Range: Dir (Direct) or Rev (Reverse)

Set the motor direction to either Direct (clockwise, 0 to 90°), or Reverse (counter clockwise, 90 to 0°). **Go to Step 16.**

12. "SELECT TO1 CLOSE PERCENT"

TO1 Default: 40% of demand
Range: 20%, 40%, 60%, 80%

This option appears if you selected OnOf at Step 8. Select the percentage at which you want TO1 to close (at % of demand of the ramp selected at Step 9). Contact automatically opens at 0% of the demand.

TRIAC Output 2 (TO2)

13. "SELECT TO2 OUTPUT SIGNAL"

TO2 Default: OnOf (on/off)
Range: OnOf (on/off), PULs (pulsed)

Select the desired signal from the available options.

- If you select PULs, only the Heating 1 and Heating 2 ramps will be available at Step 14.



14. "SELECT TO2 SIGNAL RAMP"

TO2 Default: Cr1 (Cooling ramp 1)
Range: Cr1, Cr2, Hr1, Hr2, COr, OFF

Select the desired ramp from the available options.

- If you selected PULs at Step 13, only Heating Ramp 1 and Heating Ramp 2 will be available.

If you selected PULs at Step 13, or OFF at this step, go to Step 16.

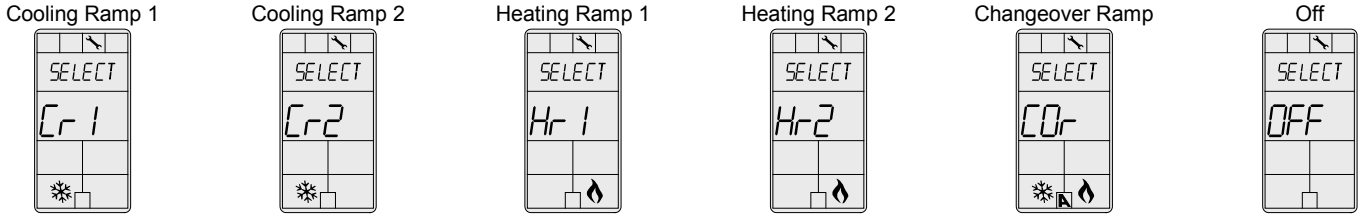

15. "SELECT TO2 CLOSE PERCENT"

TO2 Default: 40% of demand
Range: 20%, 40%, 60%, 80%

This option appears if you selected OnOf at Step 13. Select the percentage at which you want TO2 to close (at % of demand of the ramp selected at Step 14). Contact automatically opens at 0% of the demand.

TRIAC Output 3 (TO3)

16. "SELECT TO3 OUTPUT SIGNAL"

TO3 Default: OnOf (on/off)
Range: FLt (floating), OnOf (on/off), PULs (pulsed)

Select the desired signal from the available options.

- If you select FLt, ramp TO3 will be used for TO4. TO3 ramp will be set to close and TO4 will be set to open.
- If you select PULs, only the Heating 1 and Heating 2 ramps will be available at Step 9.

17. "SELECT TO3 SIGNAL RAMP"

TO3 Default: Hr1 (Heating ramp 1)
Range: Cr1, Cr2, Hr1, Hr2, COr, OFF

Select the desired ramp from the available options.

- If you selected FLt at Step 16, ramp TO1 will be used for TO2. TO1 ramp will be set to close and TO2 will be set to open.
- If you selected PULs at Step 16, only Heating Ramp 1 and Heating Ramp 2 will be available.

If you selected OnOf at Step 16, go to Step 20.

If you selected PULs at Step 16, or OFF at this step, go to Step 21.

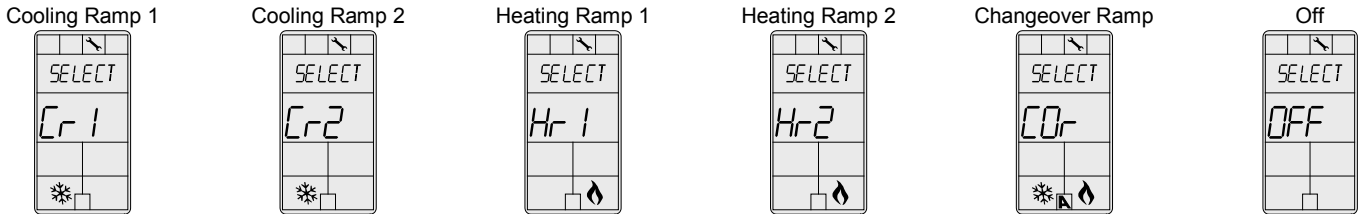

18. "SET FLOATING TIME IN SECONDS"

TO3 Default: 100 seconds
Range: 15 to 250 seconds
Increment: 5 seconds

This option appears only if you selected FLt (Floating) at Step 16. Set the desired value for floating time signal.

19. "SELECT MOTOR DIRECT REVERSE"

TO3 Default: Dir (Direct)
Range: Dir (Direct) or Rev (Reverse)

Set the motor direction to either Direct (clockwise, 0 to 90°), or Reverse (counter clockwise, 90 to 0°). Go to Step 24.



20. "SELECT TO3 CLOSE PERCENT"

TO3 Default: 40% of demand
Range: 20%, 40%, 60%, 80%

This option appears if you selected **OnOf** at Step 16. Select the percentage at which you want TO3 to close (at % of demand of the ramp selected at Step 17). Contact automatically opens at 0% of the demand.

TRIAC Output 4 (TO4)

21. "SELECT TO4 OUTPUT SIGNAL"

TO4 Default: OnOf (on/off)
Range: OnOf (on/off), PULs (pulsed)

Select the desired signal from the available options.

- If you select PULs, only the Heating 1 and Heating 2 ramps will be available at Step 22.

22. "SELECT TO4 SIGNAL RAMP"

TO4 Default: Hr2 (Heating ramp 2)
Range: Cr1, Cr2, Hr1, Hr2, COr, OFF

Select the desired ramp from the available options.

- If you selected PULs at Step 21, only Heating Ramp 1 and Heating Ramp 2 will be available.

If you selected PULs at Step 13, or OFF at this step, go to Step 24.

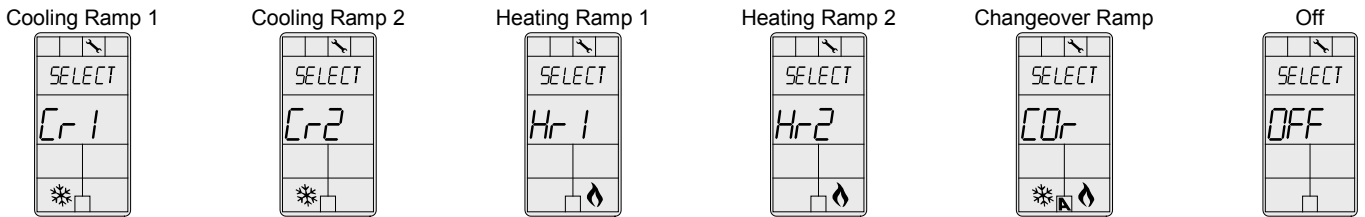

23. "SELECT TO4 CLOSE PERCENT"

TO4 Default: 40% of demand
Range: 20%, 40%, 60%, 80%

This option appears if you selected **OnOf** at Step 21. Select the percentage at which you want TO2 to close (at % of demand of the ramp selected at Step 22). Contact automatically opens at 0% of the demand.

Analog Outputs (AO1 and AO2)

24. "SELECT AO1 ANALOG RAMP"

AO1 Default: Cr1 (Cooling ramp 1)
Range: Cr1, Cr2, Hr1, Hr2, COr, OFF

Select the desired ramp from the available options.

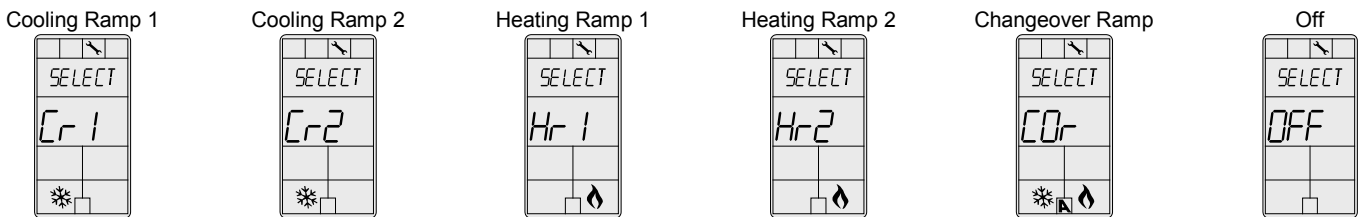



25. "SELECT AO2 ANALOG RAMP"

AO2 Default: Hr1 (Heating ramp 1)
Range: Cr1, Cr2, Hr1, Hr2, COr, OFF

Select the desired ramp from the available options.

If you selected OFF for AO1, go to Step 29.

If you selected OFF for both AO1 and AO2, go to Step 32.

Cooling Ramp 1



Cooling Ramp 2



Heating Ramp 1

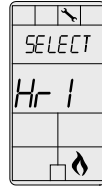

Heating Ramp 2

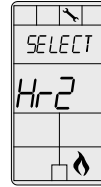

Changeover Ramp

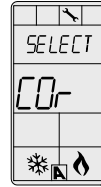

Off



26. "MIN VDC ANALOG AO1 OUTPUT"

AO1 Default: 0.0 Volt
Range: 0.0 to 10.0 Volts
Increment: 0.1 Volt

This option does not appear if the signal ramp for AO1 is set to OFF (Step 24). Select the desired minimum voltage ("zero" value) for the AO1 ramp. The minimum value is restricted by the maximum value (Step 27). In other words, the minimum value should be less than the maximum value.

27. "MAX VDC ANALOG AO1 OUTPUT"

AO1 Default: 10.0 Volts
Range: 0.0 to 10.0 Volts
Increment: 0.1 Volt

This option does not appear if the signal ramp for AO1 is set to OFF (Step 24). Select the desired maximum voltage ("span" value) for the AO1 ramp. The maximum value is restricted by the minimum value (Step 26). In other words, the maximum value should not be less than the minimum value.

28. "MIN POS AO1 OUTPUT PERCENT"

AO1 Default: 0%
Range: 0 to 100%
Increment: 5%

This option does not appear if the signal ramp for AO1 is set to OFF (Step 24). Select the desired minimum position of the AO1 analog output.

29. "MIN VDC ANALOG AO2 OUTPUT"

AO2 Default: 0.0 Volt
Range: 0.0 to 10.0 Volts
Increment: 0.1 Volt

This option does not appear if the signal ramp for AO2 is set to OFF (Step 25). Select the desired minimum voltage ("zero" value) for the AO2 ramp. The minimum value is restricted by the maximum value (Step 30). In other words, the minimum value should be less than the maximum value.

30. "MAX VDC ANALOG AO2 OUTPUT"

AO2 Default: 10.0 Volts
Range: 0.0 to 10.0 Volts
Increment: 0.1 Volt

This option does not appear if the signal ramp for AO2 is set to OFF (Step 25). Select the desired maximum voltage ("span" value) for the AO2 ramp. The maximum value is restricted by the minimum value (Step 29). In other words, the maximum value should not be less than the minimum value.

31. "MIN POS AO2 OUTPUT PERCENT"

AO2 Default: 0%
Range: 0 to 100%
Increment: 5%

This option does not appear if the signal ramp for AO2 is set to OFF (Step 25). Select the desired minimum position of the AO2 analog output.



Analog Inputs (AI1 to AI3)



32. "SELECT AI1 INPUT SIGNAL"



Default: OFF
Range: OFF, SENs, NoCL, NoHt, EtS, nSb, PrSd, PrSa

Select the input signal type for AI1 (analog input 1).

- If NoCL is selected: heating mode activates when the contact is closed and cooling mode activates when the contact is opened.
- If NoHt is selected: cooling mode activates when the contact is closed and heating mode activates when the contact is opened.
- If SENs is selected: heating mode activates when the temperature read by the external sensor is above the Changeover Setpoint and cooling mode activates when the temperature read by the external sensor is below the Changeover Setpoint (see Step 36).
- If PrSd or PrSa is selected in a pressure independent VAV system, you must perform a calibration by using the Air Flow Program Mode (Operation Mode) on page 12.

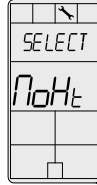
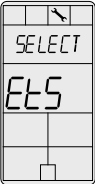
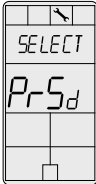
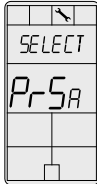
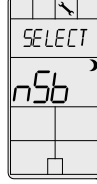
Off 	External Changeover Sensor 10kΩ 	Changeover Contact Normally Cool 	Changeover Contact Normally Heat 
External Temperature Sensor 10kΩ 	Differential Pressure Sensor (0-10Vdc, PrSd=1-V if P=1) 	Velocity Pressure Sensor (0-10Vdc, PrSa 10V=Vnom) 	Night Set Back Contact 

33. "SELECT AI2 INPUT SIGNAL"



Default: OFF
Range: OFF, SENs, NoCL, NoHt, EtS, nSb, PrSd, PrSa

Select the input signal type for AI2 (analog input 2). Same options as in Step 32.

- The AI1 input signal has priority over AI2. If you select the same input signal type as AI1, AI2 will not be functional.

34. "SELECT AI3 INPUT SIGNAL"



Default: OFF
Range: OFF, SENs, NoCL, NoHt, EtS, nSb, PrSd, PrSa

Select the input signal type for AI3 (analog input 3). Same options as in Step 32.

- The AI1 and AI2 input signals have priority over AI3. If you select the same input signal type as AI1 or AI2, AI3 will not be functional.

35. "EXTERN TEMPER SENSOR OFFSET"



Range: 0 to 50°C [41 to 122°F]Max. ± 5°C
Offset: 0.1°C [0.2°F]
Increment:

This option appears if you've set one of the analog inputs to **EtS** (External temperature sensor) in Step 32, 33 or 34. When the thermostat is connected to the appropriate analog input (AI1, AI2, or AI3), the display shows the temperature read by the external temperature sensor. Adjust the offset by comparing it with a known value (e.g. thermometer). If the sensor is not connected or short circuited, the display is blank "Error".



36. "CH OVER SETPNT TEMPER"



Default: 24°C [82°F]
Range: 10 to 40°C [50 to 104°F]
Increment: 0.5°C [1°F]

This option appears if you've set one of the analog inputs to **SEns** (External changeover sensor) in Step 32, 33 or 34. Set the desired changeover temperature setpoint. Please note that the heating mode activates when the temperature read by the external sensor is above the Changeover Setpoint and cooling mode activates when the temperature read by the external sensor is below the Changeover Setpoint.

37. "NSB DELAY OVERRIDE MINUTES"



Default: 120 minutes
Range: 0 to 180 minutes
Increment: 15 minutes

This option appears if you've set one of the analog inputs to **nSb** (Night set back contact) in Step 32, 33 or 34. When in Night Set Back mode, the end user can override the Night Set Back setpoints for the duration of this delay (refer to Operation Mode on page 14). To disable Night Set Back override, set the delay to 0. The moon symbol is displayed to indicate "Night Set Back" mode.

38. "NIGHT SETBACK HEATING SETPNT"



Default: 16°C [61°F]
Range: 10 to 40°C [50 to 104°F]
Increment: 0.5°C [1°F]

This option appears if you've set one of the analog inputs to **nSb** (Night set back contact) in Step 32, 33 or 34. Set the heating setpoint that will be used when the system is "Night Set Back" Mode. The setpoint value is restricted by the "Night Setback Cooling Setpnt" value (Step 39). The moon and heating symbols are also displayed.

39. "NIGHT SETBACK COOLING SETPNT"



Default: 28°C [82°F]
Range: 10 to 40°C [50 to 104°F]
Increment: 0.5°C [1°F]

This option appears if you've set one of the analog inputs to **nSb** (Night set back contact) in Step 32, 33 or 34. Set the cooling setpoint that will be used when the system is "Night Set Back" Mode. The setpoint value is restricted by the "Night Setback Heating Setpnt" value (Step 38). The moon and heating symbols are also displayed.

40. "PRESSUR INDEPEN OUTPUT"



Default: FLt.1 (floating 1)
Range: FLt.1, FLt.2, ANL.1, ANL.2

This option appears if you've set one of the analog inputs to either **PrSd** or **PrSa** (pressure sensor) in Step 32, 33 or 34. Select which output is affected by pressure (connected to the actuator). These selections may vary based on options selected at Step 8 and 16.

Floating 1
(TO1 & TO2)



Floating 2
(TO3 & TO4)



Analog 1
(AO1)



Analog 2
(AO2)



41. "CONTROL RAMP CH OVER"



Default: 2.0°C [4°F]
Range: 0.5 to 5.0°C [1 to 10°F]
Increment: 0.5°C [1°F]

Select the desired proportional band value of the changeover ramp. The cooling* and heating symbols are also displayed.

42. "CONTROL RAMP 1 HEATING"



Default: 2.0°C [4°F]
Range: 0.5 to 5.0°C [1 to 10°F]
Increment: 0.5°C [1°F]

Select the desired proportional band value of the heating ramp 1. The heating symbol is also displayed.



43. "CONTROL RAMP 2 HEATING"



Default: 2.0°C [4°F]
Range: 0.5 to 5.0°C [1 to 10°F]
Increment: 0.5°C [1°F]

Select the desired proportional band value of the heating ramp 2. The heating symbol is also displayed.

44. "CONTROL RAMP 1 COOLING"



Default: 2.0°C [4°F]
Range: 0.5 to 5.0°C [1 to 10°F]
Increment: 0.5°C [1°F]

Select the desired proportional band value of the cooling ramp 1. The cooling symbol is also displayed.

45. "CONTROL RAMP 2 COOLING"



Default: 2.0°C [4°F]
Range: 0.5 to 5.0°C [1 to 10°F]
Increment: 0.5°C [1°F]

Select the desired proportional band value of the cooling ramp 2. The cooling symbol is also displayed.

46. "CONTROL DEAD BAND CH OVER"



Default: 0.3°C [0.6°F]
Range: 0 to 5.0°C [0 to 10°F]
Increment: 0.1°C [0.2°F]

Select the desired dead band value of the changeover ramp. The cooling and heating symbols are also displayed.

47. "CONTROL DEAD BAND 1 HEATING"



Default: 0.3°C [0.6°F]
Range: 0 to 5.0°C [0 to 10°F]
Increment: 0.1°C [0.2°F]

Select the desired dead band value of the heating ramp 1. The heating symbol is also displayed.

48. "CONTROL DEAD BAND 2 HEATING"



Default: 0.3°C [0.6°F]
Range: 0 to 5.0°C [0 to 10°F]
Increment: 0.1°C [0.2°F]

Select the desired dead band value of the heating ramp 2. The heating symbol is also displayed.

49. "CONTROL DEAD BAND 1 COOLING"



Default: 0.3°C [0.6°F]
Range: 0 to 5.0°C [0 to 10°F]
Increment: 0.1°C [0.2°F]

Select the desired dead band value of the cooling ramp 1. The cooling symbol is also displayed.

50. "CONTROL DEAD BAND 2 COOLING"



Default: 0.3°C [0.6°F]
Range: 0 to 5.0°C [0 to 10°F]
Increment: 0.1°C [0.2°F]

Select the desired dead band value of the cooling ramp 2. The cooling symbol is also displayed.

51. "COOLING ANTI CYCLE MINUTES"



Default: 2 minutes
Range: 0 to 15 minutes
Increment: 1 minute

To protect the compressor, set the delay in minutes before activating or reactivating the cooling contact.

52. "ADJUST INTGRAL TIME IN SECONDS"



Default: 0 seconds
Range: 0 to 250 seconds
Increment: 5 seconds

Set the desired value for the integration factor compensation.



53. "ENABLE ANTI FREEZE PROTECT"



Default: No (disabled)
Range: No, Yes

If this option is enabled, heating starts automatically when the temperature drops to 4°C [39°F], even if the thermostat is in OFF mode. Once the temperature reaches 5°C [41°F], the heating stops.

Air Flow Program Mode (Operation Mode)

This menu is accessible through normal operation mode.

1. The Mode Selector DIP switch (DS1) must be set to the "OFF" position (Operation Mode). Refer to Wiring on page 2.
2. Press the and keys for 5 seconds. The "ENTER PASSWORD" screen appears.
3. Enter the password (637) within 1 minute. Use the and arrow keys to increase or decrease the value and the buttons to toggle between the digits. If you enter the wrong password, the thermostat displays "Error" and returns to Operation Mode.
4. Use the same menu operations as described in Programming Mode on page 3.

The thermostat will return to normal mode if you navigate through the entire menu and do not make any selection, or if you do not press any key for 5 minutes. The changed values will be saved automatically.

54. "INSIDE TEMP SENSOR OFFSET"



Range: 10 to 40°C [50 to 104°F]
Offset: Max ± 5°C
Increment: 0.1°C [0.2°F]

Compare the displayed temperature reading with a known value from a thermometer. To offset or calibrate the sensor, use the arrows key to set the desired temperature reading. This is useful for thermostats installed in areas where the temperature read is slightly different than the room's actual temperature. For example, a thermostat placed right under the air diffuser.

If the thermostat is set to use an external temperature sensor (EtS at Step 32, 33 or 34 of programming mode on page 9), the thermostat displays "OFF".

55. "EXTERN TEMPER SENSOR OFFSET"



Range: 0 to 50°C [41 to 122.0°F]
Offset: Max ± 5°C
Increment: 0.1°C [0.2°F]

This option appears if you've set one of the analog inputs to EtS (External temperature sensor) in Step 32, 33 or 34 of programming mode on page 9. When the thermostat is connected to the appropriate analog input (AI1, AI2, or AI3), the display shows the temperature read by the external temperature sensor. Adjust the offset by comparing it with a known value (e.g. thermometer). If the sensor is not connected or short circuited, the display is blank "Error".

56. "PRESSURE FILTER TIME IN SECONDS"



Default: 2 seconds
Range: 1 to 10 seconds
Increment: 1 second

This option appears if you have set one of the analog inputs to PrSd or PrSa in Step 32, 33, or 34. Set the time in seconds of the numeric filter applied to the pressure analog input. The numeric filter stabilizes the reading and slows down the answer of the system.

57. "AIR FLOW INTGRAL TIME IN SECONDS"



Default: 0 minutes
Range: 0 to 60 minutes
Increment: 1 minute

Set the time in minutes for the integration factor compensation.

58. "ADJUST AIRFLOW KFACTOR VNMOM"



Default: 1200
Range: 100 to 9995
Increment: 5

Set the value of the K-Factor or the V nominal according to your pressure sensor selection (PrSd or PrSa in Step 32, 33 or 34 or programming mode on page 9).

- If Differential Pressure Sensor (PrSd): $V = k\sqrt{\Delta P}$ when $\Delta P=1$ (10.00V)
- If Velocity Pressure Sensor (PrSa): $V_{nom} = 10.00V$



59. "MINIMUM COOLING AIRFLOW"

-  Default: 100
- Range: 0 to "maximum cooling airflow"
- Increment: 5

Select the desired value of the minimum airflow in cooling. The minimum value is restricted by the maximum value (Step 60).

60. "MAXIMUM COOLING AIRFLOW"

-  Default: 1000
- Range: "minimum cooling airflow" to "K-Factor or V nominal"
- Increment: 5

Select the desired value of the maximum airflow in cooling. The maximum value is restricted by the minimum value (Step 59).

61. "MINIMUM HEATING AIRFLOW"

-  Default: 100
- Range: 0 to "maximum heating airflow"
- Increment: 5

Select the desired value of the minimum airflow in heating. The minimum value is restricted by the maximum value (Step 62).

62. "MAXIMUM HEATING AIRFLOW"

-  Default: 1000
- Range: "minimum heating airflow" to "K-Factor or V nominal"
- Increment: 5

Select the desired value of the maximum airflow in heating. The maximum value is restricted by the minimum value (Step 61).

63. "ENABLE AIRFLOW BALANCE"

-  Default: No
- Range: No, Yes

If you do not need to balance system, select **No**. This will exit the Air Flow and BACnet Setup menu and return to operation mode. If you want to balance system, select **Yes**. In this case, continue to the next step and if no action occurs for 30 minutes, changed values will be saved and the thermostat will exit the Air Flow Setup menu and return to operation mode.

64. "MINIMUM AIRFLOW"

-  Range: 0 to "K-Factor or V nominal"
- Offset: Max. ± ½ value
- Increment: 1

The thermostat displays the minimum airflow detected by the pressure sensor. The thermostat will send a signal to the actuator to close the VAV box at minimum airflow. When the value on thermostat is stable, adjust the calibration of the sensor by comparing it with the reading on a manometer or a balometer. If you can't stabilize the system, you may need to increase the filter time value (Step 56).

65. "MAXIMUM AIRFLOW"

-  Range: 0 to "K-Factor or V nominal"
- Offset: Max. ± ½ value
- Increment: 1

The thermostat displays the maximum airflow detected by the pressure sensor. The thermostat will send a signal to the actuator to open the VAV box at maximum airflow. When the value on thermostat is stable, adjust the calibration of the sensor by comparing it with the reading on a manometer or a balometer. If you can't stabilize the system, you may need to increase the filter time value (Step 56). **Return to Step 63.** To exit the Air Flow Setup mode, set the Mode Selector DIP switch (DS1) must be set to "ON" position (Programming Mode).



Operation Mode

The Mode Selector DIP switch (DS1) must be set to the “OFF” position (Operation Mode). Refer to Wiring on page 2.

Operation Mode

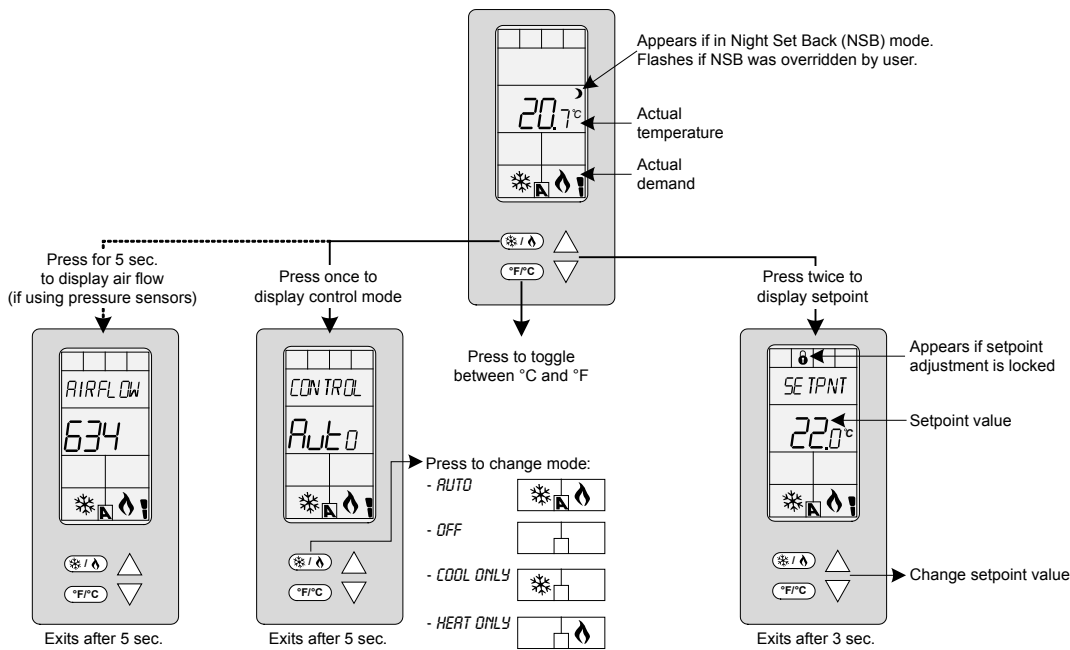

Power Up

Upon power up, the LCD illuminates and all segments appear for 2 seconds. The thermostat then displays its current version for 2 seconds.

LCD Backlight

Pressing any key on the thermostat illuminates the LCD for 4 seconds.

Temperature

The thermostat always displays the temperature reading. If the sensor is disconnected or short circuited, then “OFF” and “- -” are displayed. To toggle the temperature scale between °C and °F, press the key.

Setpoint

To display the setpoint, press the or key twice. The setpoint appears for 5 seconds. To adjust the setpoint, press the arrow keys while the temperature is displayed. If the setpoint adjustment has been locked (Step 4 on page 4), the lock symbol appears.

Control Mode

To access the Control Mode, press the key. The Control Mode appears for 5 seconds. Press the key to scroll through the following control modes. These options can vary depending on the options selected at Steps 6 and 7 on page 4.

- Auto (Automatic Cooling or Heating)
- Cooling only (on)
- Heating only (on)
- OFF

Night Set Back (NSB)

This function is only available if you’ve set one of the analog inputs to **nSb** (Night set back contact) in Step 32, 33 or 34 on page 9. If the NSB contact is triggered, the thermostat enters NSB Mode (the symbol appears) and uses the NSB setpoints defined in Steps 38 and 39 on page 10. The user can press any key to override NSB for the delay defined at Step 37 on page 10. The symbol flashes to indicate that the NSB mode is overridden (during this time the standard setpoints are used).

Air Flow

This function is only available if you’ve set one of the analog inputs to either **PrSd** or **PrSa** (pressure sensor) in Step 32, 33 or 34 on page 9. Press and hold the key for 5 seconds to display the airflow value.



Notes

	Recycling at end of life: please return this product to your Neptronic local distributor for recycling. If you need to find the nearest Neptronic authorized distributor, please consult www.neptronic.com .
---	---



neptronic[®]

400 Lebeau blvd, Montreal, Qc, H4N 1R6, Canada

www.neptronic.com

Toll free in North America: 1-800-361-2308

Tel.: (514) 333-1433

Fax: (514) 333-3163

Customer service fax: (514) 333-1091

Monday to Friday: 8:00am to 5:00pm (Eastern time)