



Installation Instructions and User Manual



READ AND SAVE THESE INSTRUCTIONS



Foreword

Neptronic Company Overview

Founded in 1976, we're a private corporation that designs, manufactures, and distributes products for the HVAC industry. Our product line includes intelligent controllers, electronic actuators, actuated valves, humidifiers and electric heaters.

Our products are designed and manufactured by over 250 dedicated employees in our 7,500 m² (80,000 ft²) state-of-the-art facility located in Montreal, Canada. Using a vertical integration model, our entire manufacturing chain is under one roof from software and hardware development to SMT circuit board assembly, to sheet metal fabrication, to product testing ensuring that our products are engineered to last.

We currently hold several national and international patents, and with our continued commitment to research and development, we provide innovative products and technologies for the ever-evolving challenges of the HVAC industry. Exporting over 70% of our sales, we have an exclusive distribution network around the globe that provides comprehensive solutions to our worldwide customers.

About the Manual

These installation and operation instructions have been developed to facilitate the installation of the Hot Yoga Climate Tower.

- The strict application of these instructions ensures the conformity of your installation and operation as per the manufacturer's recommendations.
- The application of these instructions is one of the conditions for the application of the warranty.
- The application of these instructions does not ensure, at any time conformity to procedures, regulation, or local codes, regarding electric connection and installation to local water supply.

This product has been declared to conform to the applicable Canadian and American safety standards and directives and bear the CSA (c) & (us) mark. The Certificate of Conformity, CSA is available, upon request with the manufacturer.

Copyright Information

Copyright © 2022 by Neptronic.

All rights reserved. This document cannot be reproduced wholly or partially by any means whether, electronic, mechanical, photocopy, recording or other, without prior written authorization of Neptronic.

Electricity



All work concerned with electrical installation **MUST** only be performed by skilled and qualified personnel such as an electrician or a technician with appropriate training). The customer is always responsible for ensuring the suitability of the technical personnel.

Please observe the local regulations concerning the provision of electrical installations.

Correct Use

Neptronic systems and its products are designed only for heating, ventilation, and humidification use. Any other application is not considered appropriate for the intended purpose. The manufacturer cannot be made liable for any damage resulting from incorrect use.

General Warranty

To view the complete Neptronic General Conditions of Sale and Warranty, go to www.neptronic.com/Sales-Conditions.

Lists

Illustrations

Illustration 1 - HAVA Hot Yoga Climate Tower Components Overview	5
Illustration 2 - HAVA Hot Yoga Enclosure Specifications - Overview	7
Illustration 3 - Positioning the Hot Yoga Climate Tower	9
Illustration 4 - Water Supply Connections	10
Illustration 5 - Drain Connections	11
Illustration 6 - Display Features: Front Panel	13
Illustration 7 - Cleaning the Evaporation Chamber	35

Tables

Table 1 - Power Supply Information: North America	6
Table 2 - Electric Heater Technical Specifications	6
Table 3 - Hot Yoga Climate Tower Enclosure Specifications	7
Table 4 - Humidifier Front Panel Display Description	13
Table 5 - Scroll Mode Display Description	14
Table 6 - Diagnostic Mode Display Descriptions	14

Contents

Overview	4
Product Description	4
Features	4
Technical Specifications	6
Power Supply Information – North America	6
Electric Heater Technical Specifications	6
Enclosure Specifications	7
Enclosure Specifications - Visual Overview	7
UV-C Lamps	7
Handling and Packing	8
Mechanical Installation	9
Unit Positioning	9
Fan and Air Inlet	10
Water Supply Installation	10
Water Drain Connection	11
Power Supply Connections	12
Power Supply Wiring	12
Display	13
Front Panel	13
Modes – Description	14
OFF Mode	14
Scroll Mode	14
Diagnostic Mode	14
Programming Mode	15



Hot Yoga Unit Controller and Room Sensor	16
Description	16
Features	16
Applications.....	16
System	16
Technical Specifications	17
Wiring.....	18
Jumpers	18
Mounting Instructions.....	19
Programming Mode	19
Setpoint and User Control.....	20
TRIAC Output (TO1)	21
TRIAC Output (TO2)	22
TRIAC Output (TO3)	23
Analog Output (AO1).....	23
Analog Output (AO2).....	24
Analog Output (AO3).....	25
Control Ramps	25
Other Settings	26
Fan Settings	26
External Temperature Sensor (AI1)	28
Digital Input (DI1)	28
Humidity Settings (AI2)	29
Anti-Freeze.....	29
Operation Mode	30
Power Up.....	30
LCD Backlight.....	30
Temperature and Humidity.....	30
Temperature Setpoint	30
Humidity Setpoint	31
Control Mode.....	31
Fan Speed Selection Mode.....	31
Start-up Procedure	32
Service.....	32
Heater – General Maintenance.....	32
Maintenance.....	32
Replace Air Filters and UV Lamp.....	33
Humidifier – General Maintenance.....	33
Cleaning the Evaporation Chamber	33
Wiring	37

Overview

Product Description

The Hot Yoga studio system is a complete turnkey system; a fully integrated system that includes ventilation, heating, humidification, fresh air, and energy conservation with closed proportional control, easy installation, and maintenance. Our systems are designed to reliably maintain 104°F (40°C) with 50%RH in the space of up to 7060 ft³ (200 m³). The air supply can come directly from the room or a local duct network.

The Hot Yoga Climate Tower is a combination of the following components:

- **Modulating Electric Heater:**  The climate tower comes with a built-in modulating electric heater with a tubular element that provides the required heating.
- **3-Speed fan:**  The 3-speed fan ensures an even heating and distribution of air.
- **Resistive Electric Steam Humidifier:**  The Hot Yoga Climate Tower comes with a built-in resistive electric steam humidifier that generates the required steam to maintain the desired humidity level of 50% RH. The Evaporation Chamber is an assembly of a metal cylinder and cover, equipped with one or several heater elements. This evaporation chamber produces the required steam.

Features

The following are the features of HAVA Series Hot Yoga System:

- 3-in-1: Heating, ventilation, and humidification
- External/remote temperature/humidity sensor
- 3-speed fan
- Room or outside air input
- Built-in thermostat with LCD
 - Displays temperature, humidity, and fan status
 - Adjusts temperature and humidity setpoints
 - Turns on or turns off the unit
 - Indicates system status and that the filter needs to be changed
- Integrated UV light to kill microorganisms such as bacteria, viruses, mold and other pathogens.
- Easy to install and to maintain

Visual Overview

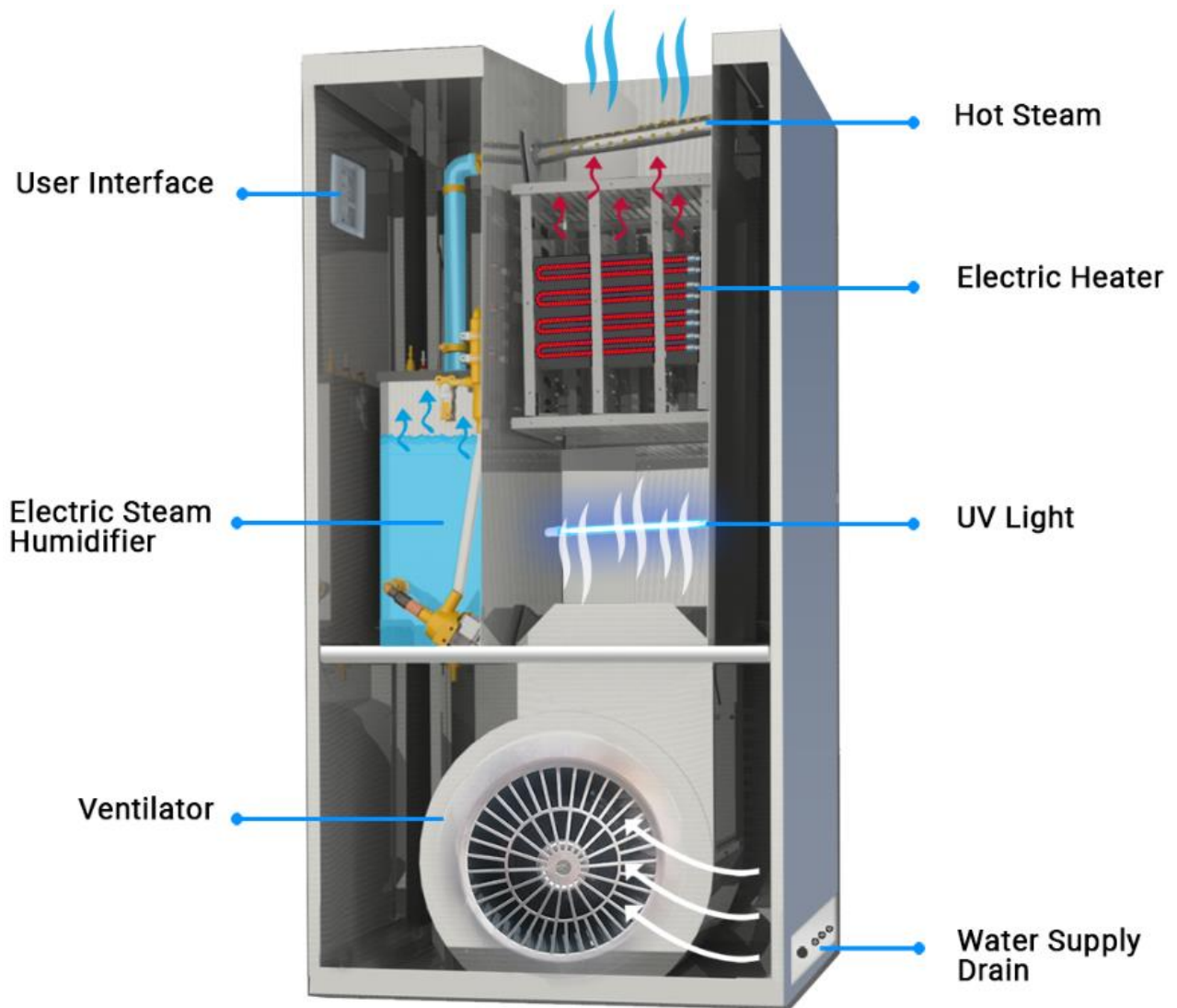

Illustration 1 - HAVA Hot Yoga Climate Tower Components Overview

Technical Specifications

Power Supply Information – North America

Table 1 - Power Supply Information: North America

Description		HVH6	HVH7	HVH10	HVH12
Surface Area		150 ft ² [13.9 m ²]	300 ft ² [27.9 m ²]	600 ft ² [55.7 m ²]	800 ft ² [74.3 m ²]
Heater	Power	6 kW	7.5 kW	10 kW	12 kW
	Current	208V/3ph = 17A (20A fuse) 240V/1ph = 25A (30A fuse)	208V/3ph = 21A (25A fuse) 240V/1ph = 32A (40A fuse)	28A (40A fuse)	34A (40A fuse)
	Delta T	24°F [13°C]	29.6°F [16°C]	39.6°F [22°C]	47.5°F [26°C]
Humidifier	Power	Up to 6 kW		Up to 16 kW	
	Current	208V/3ph = Max 17A (20A fuse) 240V/1ph = Max 25A (30A fuse)		45A (60A fuse)	
	Capacity	Max 18 lb/hr [8 kg/hr]		Max 48 lb/hr [22 kg/hr]	
Supply	Vac/ph	208/3ph		208/3ph	
		240/1ph			
Total	Current	208V/3ph = Max 34A 240V/1ph = Max 50A	208V/3ph = Max 38A 240V/1ph = Max 57A	Max 73A	Max 79A

* Refer to product label for detailed specifications

Electric Heater Technical Specifications

Table 2 - Electric Heater Technical Specifications

Specification	Description
Heater Type	Tubular Elements
Maximum Inlet Air Temperature	110°F (43°C)
Control Signal	Electric - On/Off
Contact delay (ON/OFF stage(s))	ON: 1 minute; OFF: 30 seconds

Enclosure Specifications

Table 3 - Hot Yoga Climate Tower Enclosure Specifications

Description	HAVA Hot Yoga Climate Tower
Enclosure type	Standalone steel enclosure with powder coated paint
Size (W x D x H)	29.5" x 32" x 62" (75cm x 81cm x 157.5cm)
Weight	450lb (204kg)
Air inlet dimensions	24" x 18" (61cm x 46cm)
Air outlet dimensions	Square 15" (38cm) Vertical up
Humidifier evaporation chamber material	Stainless steel
Humidifier base/pan material	
Air duct and heater material	

Enclosure Specifications - Visual Overview

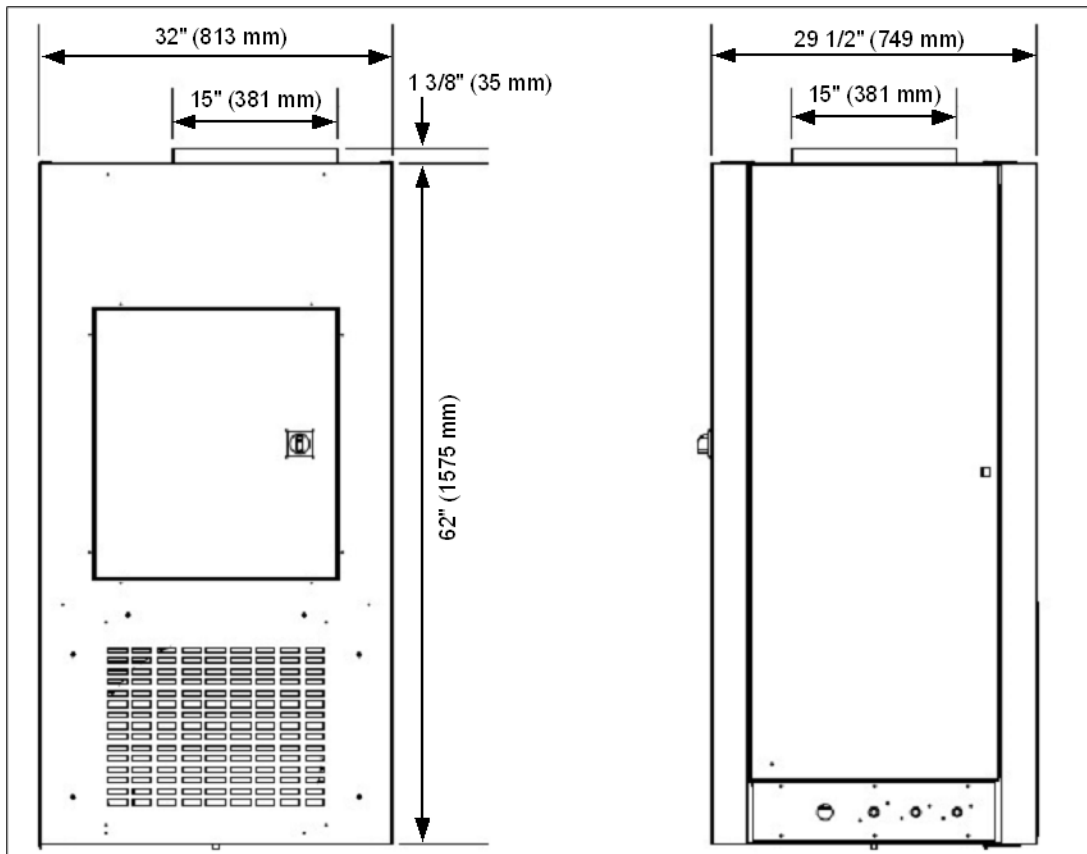

Illustration 2 - HAVA Hot Yoga Enclosure Specifications - Overview

UV-C Lamps

Replace the UV-C lamps annually. While there still may be a visible blue light, this is not an indication of UV-C output. Note that the UV-C wavelength is invisible. Contact your local UV Resources™ distributor or visit www.UVResources.com. The Neptronic part number of the lamp is **SPY3010**. The UV Resources model number for the Hornet 24Vac Residential Fixture is **SEF-12-SO-24V-1**.

Handling and Packing

Handling and Lifting

Lifting or Handling **MUST** be carried out by trained and qualified personnel. Ensure that the lifting operation is properly planned, assessed for risk and that the equipment is checked by a qualified Health and Safety representative, and effective control measures are in place.



It is the customer's responsibility to ensure that the operators are trained in handling heavy goods and to enforce the relevant lifting regulations.

The Hot Yoga Climate Tower **MUST** always be handled and lifted with care and must remain in its original packaging for as long as possible before installation.

The Hot Yoga Climate Tower package may be carried using a forklift from the bottom. Exercise caution to ensure balanced load before lifting.

Unpacking

The Hot Yoga Climate Tower is shipped inside a wooden crate. Remove packing and skids before commissioning.



WARNING: Risk of failure or malfunction. Do not operate electric heater if heating elements are damaged during transport or handling.

Do not proceed with modification or alteration to internal electric connections or components of the electric heater. Any non-authorized modification voids the warranty.

Mechanical Installation



Caution: Risk of damage and malfunction. Do not block airflow to heating elements as insufficient airflow may damage heating elements and controls on the electric heater.



WARNING: Risk of electric shock. Disconnect the Hot Yoga Climate Tower from electric supply before commencing installation.

Unit Positioning

Location

Consider the following points before deciding the location for the HAVA Hot Yoga Climate Tower:

- Plan a location that is easy to access and permits an easy inspection and servicing of the unit.
- Do not install the unit where failure of the appliance could cause damage to the building structure or to other expensive equipment.
- Ensure that the location is well ventilated.

Positioning

The Hot Yoga Climate Tower is designed to be installed directly on the floor.

- Provide a level, solid foundation and ensure that the floor beneath the unit is waterproof to withstand any water spillage during servicing or if a problem occurs.
- Ensure that the front, left, right and back of the unit are accessible in order to permit servicing:
 - Leave a clearance of at least 30" (0.8 m) to the front panel.
 - Leave a clearance of at least 24" (0.6 m) on the back, left and right sides of the unit.
 - Leave a minimum clearance of 24" (0.6 m) on top of the unit.

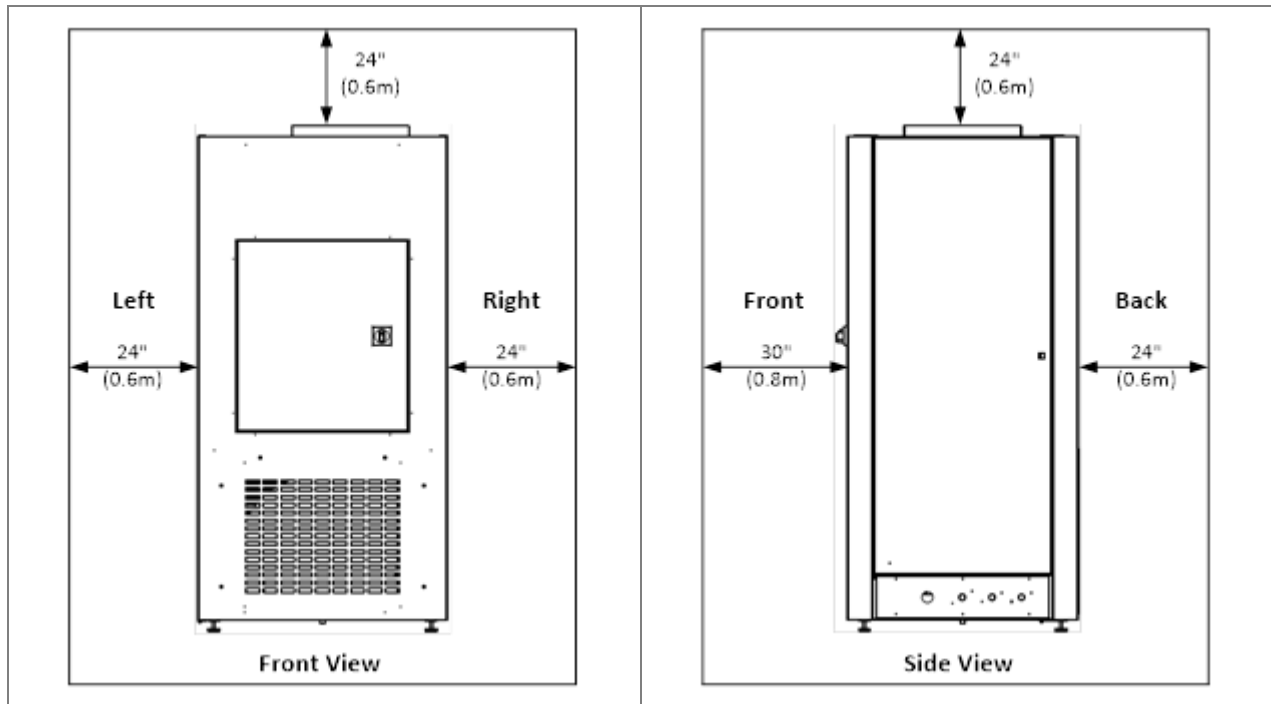

Illustration 3 - Positioning the Hot Yoga Climate Tower

Fan and Air Inlet

Fan Specification = 1500CFM

The requirements for a gym are 20CFM of fresh air per person.

Water Supply Installation



Water supply installation must conform to local codes and regulations.

Any installation work must be carried out by suitably qualified personnel.

Operation of the humidifier, which is part of a complete Hot Yoga Studio system with ventilation, heating, and humidification, is independent of variable water conditions such as soft or hard water. Therefore, pre-treatment of water is not necessary for normal operation.

Adhere to the following water inlet specifications:

- Inlet water pressure: 10 to 70 psig (0.7 to 4.8 bars)
- Maximum Water Temperature: 85°F (30°C)
- Standard copper water line connection: 3/8" (DN10)

To facilitate servicing, install a shut-off valve (not supplied) in the water supply line close to the humidifier. It is recommended to install a standard water strainer in the water supply line.

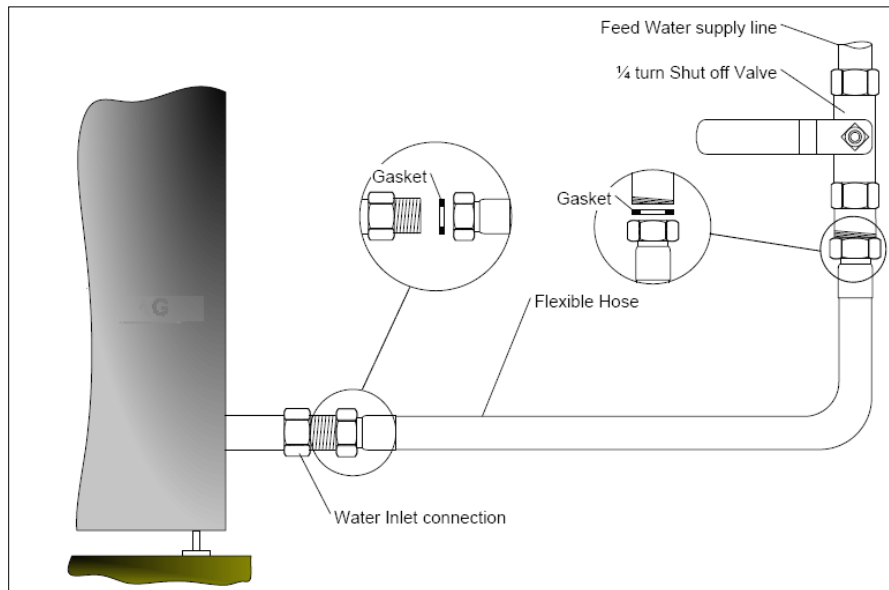

Illustration 4 - Water Supply Connections

Water Drain Connection



**Water drain installation must conform to local codes and regulations.
Any installation work must be carried out by qualified personnel.**

- Evaporation chamber water drain temperature: 140°F (60°C).
- Ensure that the drain pipe dimension is sufficient.
- Connect the water drain outlet connections to a drain pipe of sufficient size.
- Ensure that the minimum water drain pipe gradient is ¼" (6.5mm) per foot (300mm) horizontal run.
- Note that no drain trap is required.
- Connect the supplied stainless steel braided hoses to the water supply inlet and the two drain outlets as shown below.

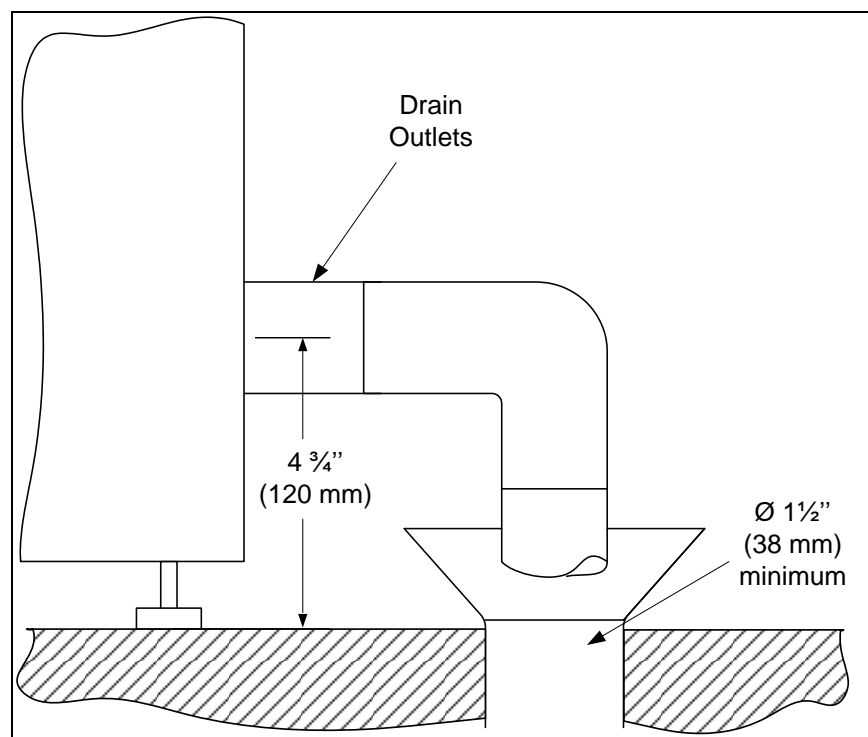

Illustration 5 - Drain Connections

Power Supply Connections



WARNING: Risk of electric shock. Disconnect the appliance from electric supply before commencing installation. Any installation work must be carried out by suitably qualified personnel.

Caution: Risk of malfunction. Use only copper wires suitable for 221°F (105°C).



If a disconnect switch and fuses are not supplied on the control panel of an electric heater, contact the supplier, and install the disconnect switch and fuses provided by the supplier.

A gauge of electric supply wires must be of appropriate section, the function of line current, as per local electrical code.

Power Supply Wiring

See the nameplate for information on voltage and current.

- Connect all wires to appropriate terminals as per the electrical diagram affixed inside the control panel door.
- Verify and tighten connections before start-up, and after a short period of operation (typically, after 2 weeks).



WARNING: Risk of fire. Do not interchange the power terminal block designated L1, L2, and L3 with low voltage terminal block designated 1, 2, and 3.

Adhere to the following guidelines when you make power supply connections:

- Use only copper conductors.
- Install an external overcurrent protection and disconnect circuit breaker on the supply, adjacent to the humidifier.
- Install a knock out (not supplied) at the bottom of the electrical compartment of the humidifier for strain relief of the supply cable.
- Ensure that the size of the wire conductors is appropriate for the current supplied.
- Ensure that each terminal connection is properly secured.
- Equip the ground conductor with a ring terminal and connect directly to the electrical panel on the indicated location.

Display

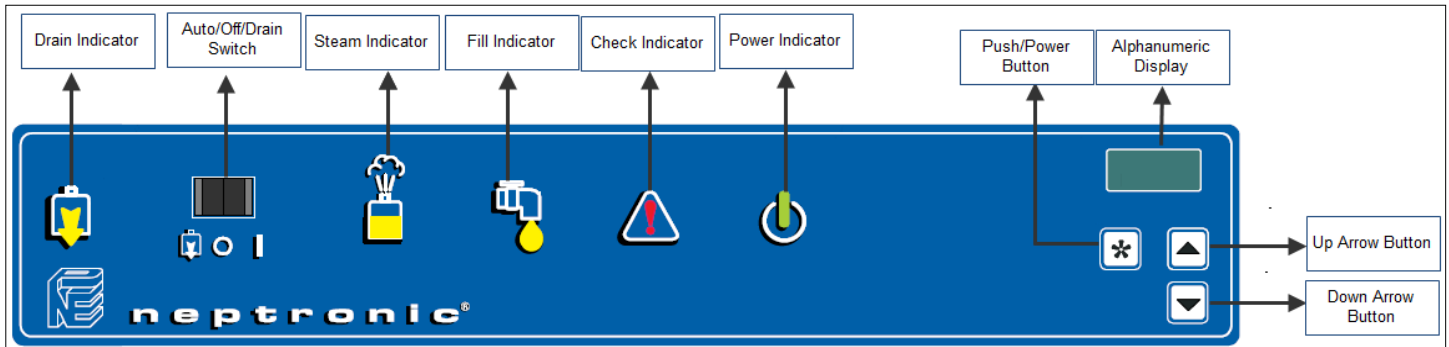











Illustration 6 - Display Features: Front Panel

Front Panel

The following are the display features of the Front Panel and their description:

Table 4 - Humidifier Front Panel Display Description

Options		Description
Alphanumeric Display		The Alphanumeric display indicates all the operation parameters and error messages.
Push/Power Button		The Push button is used to access program mode.
Up and Down Arrow Buttons	 	▲ - Used to increase the control parameters of the humidifier. ▼ - Used to decrease the control parameters of the humidifier.
Power Indicator		☼ - The humidifier is powered by electricity, and the switch is at the AUTO position. ○ - The humidifier is disconnected from the power supply.
Check Indicator		☼ - The CHECK indication is usually off. It is activated as a warning during abnormal conditions of operation. ☼ - If the CHECK indication is on, it means that maintenance is required. The running hours have exceeded the Service hours. ○ - No abnormal conditions of operation.
Fill Indicator		☼ - Indicates that the water supply (fill) valve is open. ○ - Indicates that the water supply (fill) valve is closed.
Steam Indicator		☼ - Indicates the ON/OFF model, the STEAM indicator illuminates when the contactor is closed, and steam is generated.
Switch Auto/Off/Drain		Auto - Position AUTO (I) Humidifier generates steam based on demand from the humidistat. OFF - Position OFF (O) - Humidifier shuts off DRAIN - Position DRAIN Humidifier stops the operation, and the evaporation chamber drains the water out. This is done typically at regular service.
Drain Indicator		☼ - Indicates that the drain pump is on, as a result of an automatic drain cycle or because the front panel switch is manually set to DRAIN. ○ - Indicates that the drain pump is off.

Modes – Description

OFF Mode

When the rocker switch is in the OFF position, the display shows the model of the humidifier and the program version number as described in the following example:

NEP 3.4
SK310M

Scroll Mode

When the rocker switch is in the auto position, the display scrolls the following information every 6 seconds:

Table 5 - Scroll Mode Display Description

Display and Description	Comment
<i>RH 25% DCT 68%</i> Display Space and Duct Relative Humidity readings	Only on modulating humidifiers (suffix M). If no High limit Duct sensor is installed, the second line is left blank.
<i>LB/HR 30</i> Quantity of steam produced by the humidifier	The actual output of the humidifier is 30 lb/hr in this example.
<i>ALARM LEVEL</i> Low water level	The humidifier shuts off, and the water supply valve is activated below this water level until sufficient level is reached.
<i>CONTROL LEVEL</i> Water level is controlled	The water supply valve is activated below this level.
<i>HIGH LEVEL</i> Water at maximum level	The water supply valve is automatically deactivated.



Diagnostic Mode

The diagnostic messages override the scrolling information when the following conditions occur:

Table 6 - Diagnostic Mode Display Descriptions

Display	Description
<i>NO DEMAND</i>	Modulating humidifier: No analog signal to the humidifier.
<i>SAFETY OPEN</i>	Airflow is not detected by the air pressure switch (modulating humidifier only)
<i>DRAIN CYCLE</i>	The humidifier is in the automatic drain mode.
<i>CONTACT DELAY</i>	15-second delay for the power contactor to be activated.
<i>OVERHEATED</i>	The temperature inside the container has exceeded the boiling temperature. The humidifier has shut off automatically.
<i>PROBE DEFECTED</i>	The water level sensor is not operational. The humidifier has shut off automatically.
<i>NO LEVEL</i>	Water has not reached the level probe.
<i>FOAMING CYCLE</i>	The Anti-Foam Energy Conservation (AFEC) has detected foam. The humidifier drains for a few minutes and returns to normal operation.
<i>DRN/PROB BLOCK</i>	The humidifier drains the water but the water level does not decrease; the humidifier has automatically shut off.

Programming Mode

To access the Programming Mode, push the  button. To move to the next program function, press the button twice. Use the  and  buttons to make any selection.

The changes made in the Program Mode are saved into a non-volatile memory. When the humidifier is in the menu-driven Program Mode, the standard operation of the humidifier is halted. To resume normal operation, exit the program mode by pressing the  button until the alphanumeric display is clear.

1. **DRAIN 8 HRS**



Default: 4 hours
Range: 1 to 24 hours

Select the frequency for drain cycle. Increase the frequency of the drain cycle when the water hardness is high. Drain cycle setting does not affect the AFEC system.

2. **RUNNING 0645 HRS**

Number of running hours (information display only)

Indicates the number of hours the humidifier has been running since the last servicing.

After every service, reset the number of hours of operation to zero by pressing the  and  buttons simultaneously for 15 seconds. This avoids the CHECK indicator from flashing.

3. **SERVICE 1000 HRS**

Default: 1000 hours
Range: 400 to 1500 hours

Set the number of hours of operation before the humidifier calls for servicing. Reduce the number of hours of operation when the water hardness is high before initiating the service.

4. **LOCK ON 80% PWR**

Default: 100 %
Range: 0% to 100%

Select the output span; the rate at which the humidifier delivers 80% of the maximum rated output at full demand.

Hot Yoga Unit Controller and Room Sensor

Model

TFH24P3-HY1

Description

The TFH24P3-HY1 is a fully configurable controller and room sensor designed specifically to function with a Neptronic Hot Yoga Studio System. A fully integrated system that includes ventilation, heating, humidification, fresh air, and energy conservation control sequences.

No additional modules are required as the required inputs, outputs, and control algorithms are built into the unit.

Features

- Configurable inputs and outputs
- Analog, On/Off, Floating or Pulsed option
- 3-speed fan contacts
- Selectable internal or external temperature sensor
- Selectable internal or external humidity sensor
- Precise temperature control with programmable PI function
- Selectable proportional control band and dead band
- Anti-freeze protection
- Low voltage operation (24V)
- Backlit LCD with simple icon and text-driven menus
- Displays temperature and humidity (room and setpoint)
- Displays control mode, demand, and alarms
- Selectable Fahrenheit or Celsius scale
- User adjustable temperature and humidity setpoints
- User adjustable control modes
- Lockable user controls

Applications

Hot Yoga Studios



TFH24P3-HY1

System

The TFH24P3-HY1 is built-in into each Neptronic Hot Yoga Studio System.

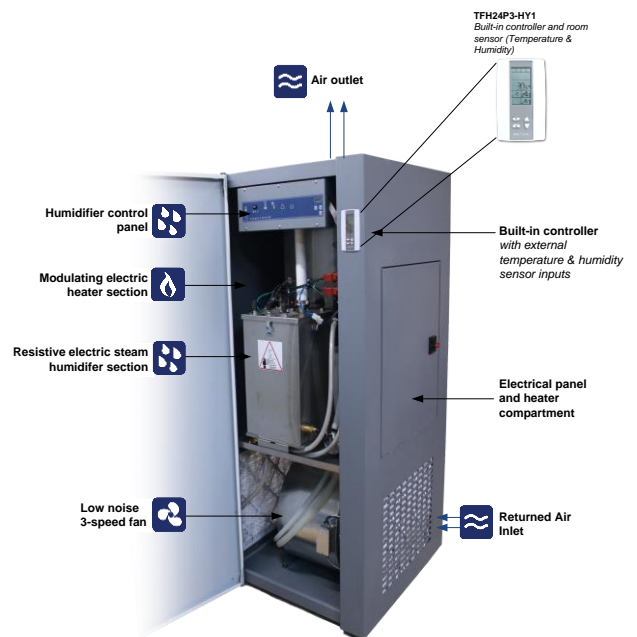

Technical Specifications

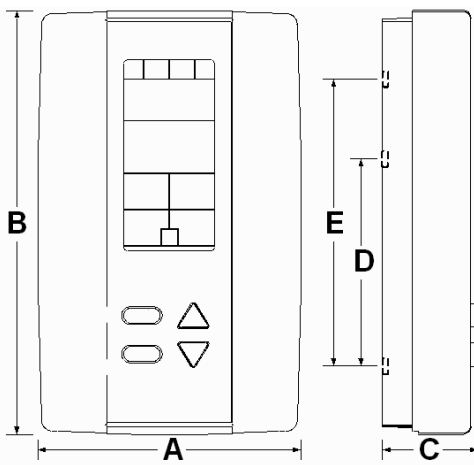
Description	TFH24P3-HY1
Inputs	1 Digital input (24Vac or dry contact) 1 Analog input (external temperature sensor); 0-10Vdc 1 Analog input (%RH); 0-10Vdc
Outputs	1 Fan analog or 3 Fan speed dry contracts 24Vac, 1A max 3A in-rush) 3 Analog outputs (cooling, heating, changeover or humidity; 0-10Vdc) 3 TRIAC outputs ((cooling, heating, changeover or humidity) 24Vac, 0.3A max fused / TRIAC 1 TRIAC output (local reheat) 24Vac, 0.3A max fused / TRIAC
Power supply	24Vac or 24Vdc
Power consumption	1VA max
Setpoint range	50°F to 122°F (10°C to 50°C), Humidity 10 to 90% RH
External sensor range	32°F to 122°F (0°C to 50°C)
Control accuracy	Temperature: ±0.8°F (±0.4°C), Humidity: ±3.5%
Proportional band	1°F to 10°F (0.5°C to 5°C) adjustable (heat/cool/ independent)
Dead Band	0°F to 10°F (0°C to 5°C) adjustable (heat/cool/ independent)
Electrical connection	18 AWG (0.8 mm ²) minimum
Operating temperature	32°F to 122°F (0°C to 50°C)
Storage temperature	-22°F to 122°F (-30°C to 50°C)
Relative Humidity	5 to 95% RH non-condensing
Degree of protection of housing	IP 30 (EN 60529)
Weight	0.36 lb. (160 g)
Certification	
Dimensions A = 2.85" 73mm B = 4.85" 123mm C = 1.00" 24mm D = 2.36" 60mm E = 3.27" 83mm	

Wiring

We strongly recommend wiring all Neptronic products to a separate grounded transformer and ensure the transformer is used to service only Neptronic products. This precaution prevents the possible damages due to incompatible equipments.

PCB		Terminals	Description	Step
		1	Common	-
		2	24 Vac	-
		3	TRIAC Input Voltage	24 Vac (external) if JP1 is set to external
		4	TRIAC Output 1 (TO1)	Heating Ramp 1 (Hr1)*
		5	TRIAC Output 2 (TO2)	OFF*
		6	TRIAC Output 3 (TO3)	OFF*
		Fan		
		7	DO Input Voltage	24 Vac (ext.): if JP2 is set to external
		8	Digital Output 1 (DO1)	-
		9	Digital Output 2 (DO2)	-
		10	Digital Output 3 (DO3)	Low* Low Low AO4
		11	Digital Input 1 (DI1)	Normally Open*
		12	Analog Input (AI1)	External Humidity Sensor*
		13	Analog Input (AI2)	External Temperature Sensor*
		14	Analog Output 1 (AO1)	Humidity (Hu)*
		15	Analog Output 2 (AO2)	OFF*
		16	Analog Output 3 (AO3)	OFF*

JP1	TRIAC Output Signal
A&B	Internal (24Vac)
B&C	External (24Vac)

JP2	Digital Output Signal
A&B	Internal (24Vac)
B&C	External (24Vac)

JP3	Mode Selection
A&B	Normal Operation
B&C	Program Mode

JP4	Fan Output Signal
A&B	Digital (Pin10=DO3)
B&C	Analog (Pin10=AO4)

Temperature Sensor

TB1

* default value

Jumpers

Jumpers	Description
JP1	TRIAC Output Signal Selector A&B = Internal: All TRIAC output signals are linked to internal 24 Vac (same as a thermostat). B&C = External: All TRIAC output signals are linked to external 24 Vac (different than thermostat).
JP2	Digital Output Signal Selector A&B = Internal: All digital output signals are linked to internal 24 Vac (same as a thermostat). B&C = External: All digital output signals is linked to external 24 Vac (different than thermostat).
JP3	Mode Selection A&B = RUN: Thermostat is in Operation Mode. (See Operation Mode, page 30) B&C = PGM: Thermostat is in Programming Mode. (See Programming Mode, page 19)
JP4	Fan Output Signal Selection A&B = Pin 10 of TB1 is set to the digital output signal (DO3). (See Step 37) B&C = Pin 10 of TB1 is set to the analog output signal (AO4). (See Step 37)

Mounting Instructions

⚠ CAUTION: Remove power to avoid a risk of malfunction.

- Remove the captive screw that is holding the base and the front cover of the unit together.
- Lift the front cover of the unit to separate it from the base.
- Pull all wires through the holes in the base.
- Secure the base to the wall using wall anchors and screws (supplied). Make the appropriate connections.
- Mount the control module on the base and secure using the screw.

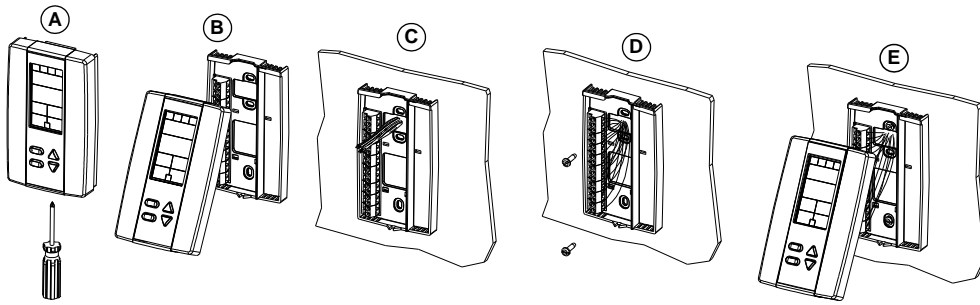

Programming Mode

Set the Mode Selector Jumper JP3 to the “PGM” mode (Programming Mode). Refer to



Wiring on page 18. Set the Jumper JP3 back to the “RUN” mode (Operation Mode) to exit. All changes will be saved.

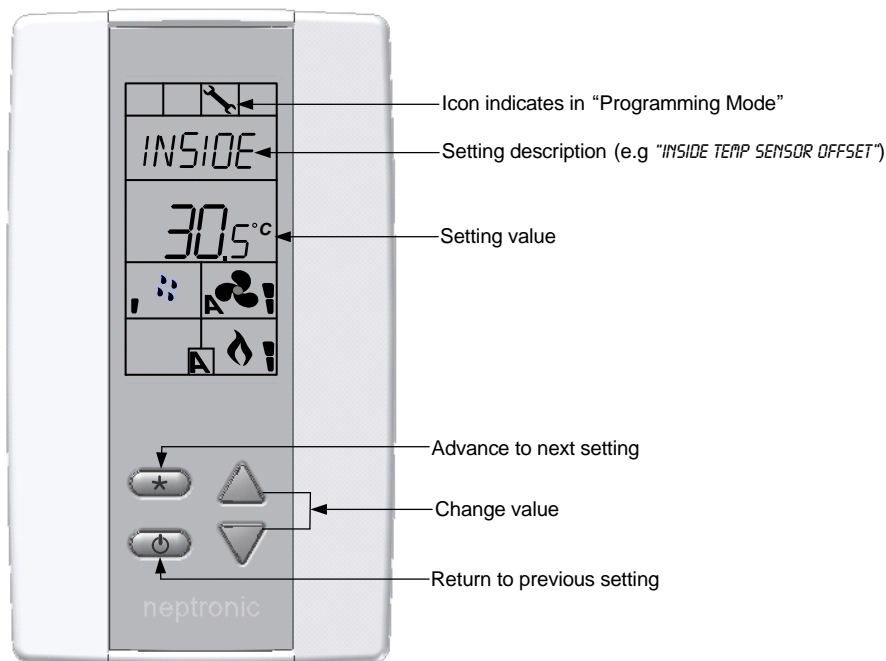

Setpoint and User Control

1. "INSIDE TEMPER SENSOR OFFSET"

	Range:	10.0 to 40.0°C	[50.0 to 104.0°F]
	Offset:	Max. ± 5°C	
	Increment:	0.1°C	[0.2°F]

Compare the displayed temperature reading with a known value from a thermometer. To offset or calibrate the sensor, use the arrow keys to set the desired temperature reading. This is useful for thermostats installed in areas where the temperature reading is different from the actual room temperature. For example, a thermostat placed right under the air diffuser. If the thermostat is set to use an external temperature sensor, (**t10.0** at Step 48), the thermostat displays "OFF".

2. "ADJUST MINIMUM USER SETPNT"

	Default:	15.0°C	[59°F]
	Range:	10.0 to 50.0°C	[50 to 122°F]
	Increment:	0.5°C	[1°F]

In Operation mode, you cannot decrease the setpoint to a lesser value than the minimum user point. The minimum value is restricted by the maximum value set at Step 3. In other words, the value that is set as the minimum cannot be greater than the maximum value.

3. "ADJUST MAXIMUM USER SETPNT"

	Default:	50.0°C	[122°F]
	Range:	10.0 to 50.0°C	[50 to 122°F]
	Increment:	0.5°C	[1°F]

In Operation mode, you cannot increase the setpoint to a higher value than the value that is set as the maximum user point. The maximum value is restricted by the minimum value set at Step 2. In other words, the value that is set as the maximum cannot be less than the minimum value.

4. "USER SETPNT LOCKED"

	Default:	No (Unlocked)
	Range:	Yes / No

If set to No, the user setpoint option is not locked and the user can adjust the desired setpoint temperature. If set to Yes, the user setpoint option is locked and the user cannot set the desired setpoint temperature. A lock symbol  appears indicating that the setpoint is locked.



5. "ADJUST INTERN SETPNT"

	Default:	22.0°C	[72°F]
	Range:	10.0 to 40.0°C	[50 to 104°F]
	Increment:	0.5°C	[1°F]

Set the desired temperature setpoint within the defined range. If the setpoint option was locked in Step 4, a lock symbol  is displayed. The setpoint value is restricted by the minimum (Step 2) and maximum (Step 3) values. In other words, the setpoint must be within in the range of minimum and maximum setpoints.

6. "ADJUST TEMPER CONTROL MODE"

	Default:	Heat (Heating Only)
	Range:	Auto (automatic cooling and heating), ON (Cooling or Heating), Heat (Heating Only), Cool (Cooling Only)

Select the control mode that you want to authorize to the user. To authorize all the available modes, select Auto (Automatic Mode). The cooling  and heating  symbols are also displayed.

7. "ENABLE ON OFF CONTROL MODE"

Default: Yes (Enable)
 Range: Yes/ No

If you select Yes, the user can set the unit to "Off" using the Control Mode (see page 31). If you select No, then the "Off" selection does not appear in the Control Mode.

TRIAC Output (TO1)
8. "TO1 SIGNAL RAMP"

Default: Hr1
 Range: COr, OFF, Hr1, Cr1, Hu

Select the desired ramp for TO1. The  symbol indicates that the fan output will be activated according to the demand.

- Hr1: Heating Ramp 1; Cr1: Cooling Ramp 1; Hu: Humidity Ramp; COr: Changeover Ramp; OFF: No signal

If you select OFF, go to Step 13, "TO2 Signal Ramp".

Changeover Ramp



OFF



Heat Ramp 1

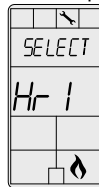

Cool Ramp 1

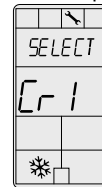

Humidity

9. "TO1 MODE"

Default: PULs (pulsed)
 Range: OnOf (on/off), FLt (floating), PULs (pulsed)

Select the desired signal from the available options.

- If you select FLt, ramp TO1 will be used for TO2. TO1 ramp will be set to close and TO2 will be set to open.
- If you selected Hr1 (Heating Ramp 1) at Step 8 "TO1 Signal Ramp", **PULs** will also be available.

If you select OnOf, go to Step 11 "Select TO1 Close Percent".

If you select PULs, go to Step 13 "TO2 Signal Ramp".

10. "SET FLOATING TIME IN SECONDS"

Default: 100 seconds
 Range: 15 to 250 seconds
 Increment: 5 seconds

This option appears only if you selected **FLt** (Floating) at Step 9, "TO1 Mode". Set the desired value for floating time signal.

Go to step 13, "TO2 Signal Ramp"

11. "SELECT TO1 CLOSE PERCENT"

Default: CL.2 % of demand
 Range: CL.2 % to CL.9 %
 Increment: 1%

This option appears if you selected **OnOf** at Step 9, "TO1 Mode". Select the percentage at which you want TO1 to close (at % of the demand of the ramp selected at Step 8, "TO1 Signal Ramp"). Contact automatically opens at 0% of the demand.

12. "SELECT TO1 OPEN PERCENT"

- 
 Default: OP.0% of demand
 Range: OP.0% to TO1 closing minus 1%
 Increment: 1%

This option appears if you selected **OnOf** at Step 9, "TO1 Mode". Select the percentage at which you want TO1 to open (at % of the demand of the ramp selected at Step 8, "TO1 Signal Ramp"). Contact automatically opens at 0% of the demand.

TRIAC Output (TO2)
13. "TO2 SIGNAL RAMP"

- 
 Default: OFF
 Range: COr, OFF, Hr1, Cr1, Hu

Select the desired ramp for TO2. The  symbol indicates that the fan output will be activated according to the demand.

- Hr1: Heating Ramp 1; Cr1: Cooling Ramp 1; Hu: Humidity Ramp; COr: Changeover Ramp; OFF: No signal

If you select **OFF**, go to Step 17 "TO3 Signal Ramp".

If you select **COr, CR1, or Hu**, go to step 15, "Select TO2 Close Percent"

Changeover Ramp



OFF



Heat Ramp 1

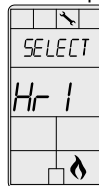

Cool Ramp 1

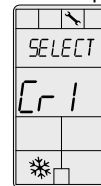

Humidity



14. "TO2 MODE"

- 
 Default: OnOf (on/off)
 Range: OnOf (on/off), PULs (pulsed)

This option appears only if you selected Hr1 (Heating Ramp 1) at Step 13, "TO2 Signal Ramp".

If you select **PULs**, go to Step 17 "TO3 Signal Ramp".

15. "SELECT TO2 CLOSE PERCENT"

- 
 Default: CL.6 % of demand
 Range: CL.6 % to CL.9 %
 Increment: 1%

This option appears if you selected **OnOf** at Step 14, "TO2 Mode". Select the percentage at which you want TO2 to close (at % of the demand of the ramp selected at Step 13, "TO2 Signal Ramp"). Contact automatically opens at 0% of the demand.

16. "SELECT TO2 OPEN PERCENT"

- 
 Default: OP.3% of demand
 Range: OP.3% to TO2 closing minus 1%
 Increment: 1%

This option appears if you selected **OnOf** at Step 14, "TO2 Mode". Select the percentage at which you want TO2 to open (at % of the demand of the ramp selected at Step 13, "TO2 Signal Ramp"). Contact automatically opens at 0% of the demand.

TRIAC Output (TO3)

17. "TO3 SIGNAL RAMP"



 Default: OFF
 Range: COr, OFF, Hr1, Cr1, Hu

Select the desired ramp for TO3. The  symbol indicates that the fan output will be activated according to the demand.

- Hr1: Heating Ramp 1; Cr1: Cooling Ramp 1; Hu: Humidity Ramp; COr: Changeover Ramp; OFF: No signal

If you select OFF, go to Step 21 "AO1 Analog Ramp".

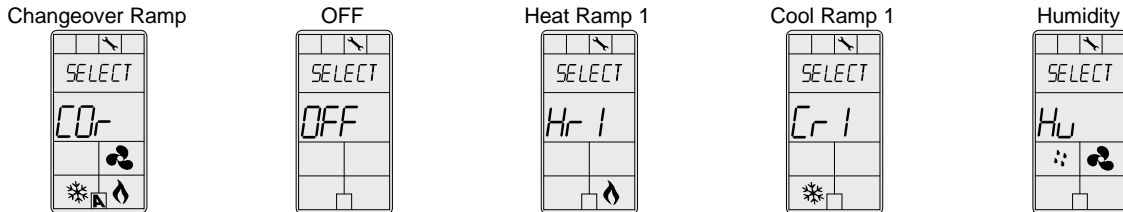
If you select COr, CR1, or Hu, go to step 19, "Select TO3 Close Percent"



18. "TO3 MODE"

 Default: OnOf (on/off)
 Range: OnOf (on/off), PULs (pulsed)

This option appears only if you selected Hr1 (Heating Ramp 1) at Step 17, "TO3 Signal Ramp".

If you select PULs, go to Step 21 "AO1 Analog Ramp".

19. "SELECT TO3 CLOSE PERCENT"

 Default: CL.2 % of demand
 Range: CL.2 % to CL.9 %
 Increment: 1%

This option appears if you selected **OnOf** at Step 18, "TO3 Mode". Select the percentage at which you want TO3 to close (at % of the demand of the ramp selected at Step 17, "TO3 Signal Ramp"). Contact automatically opens at 0% of the demand.

20. "SELECT TO3 OPEN PERCENT"



 Default: OP.0% of demand
 Range: OP.0% to TO3 closing minus 1%
 Increment: 1%

This option appears if you selected **OnOf** at Step 18, "TO3 Mode". Select the percentage at which you want TO3 to open (at % of the demand of the ramp selected at Step 17, "TO3 Signal Ramp"). Contact automatically opens at 0% of the demand.

Analog Output (AO1)

21. "AO1 ANALOG RAMP"

 Default: Hu
 Range: COr, OFF, Hr1, Cr1, Hu

Select the desired ramp from the available options. The  symbol indicates that the fan output will be activated according to the demand.

If you selected OFF, go to Step 24 "AO2 Analog Ramp".

Changeover Ramp



OFF



Heat Ramp 1

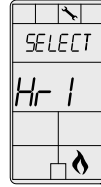

Cool Ramp 1

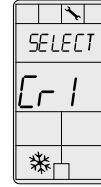

Humidity

22. "MIN VDC ANALOG AO1 OUTPUT"

- AO1** Default: 0.0 Volt
 Range: 0.0 to 10.0 Volts
 Increment: 0.1 Volt

This option does not appear if the signal ramp for AO1 is set to **OFF** (Step 21 "AO1 Analog Ramp"). Select the desired minimum voltage ("zero" value) for the AO1 ramp. The minimum value is restricted by the maximum value (Step 23 "Max Vdc analog AO1 Output"). In other words, the minimum value must be less than the maximum value.

23. "MAX VDC ANALOG AO1 OUTPUT"

- AO1** Default: 10.0 Volts
 Range: 0.0 to 10.0 Volts
 Increment: 0.1 Volt

This option does not appear if the signal ramp for AO1 is set to **OFF** (Step 21 "AO1 Analog Ramp"). Select the desired maximum voltage ("span" value) for the AO1 ramp. The maximum value is restricted by the minimum value. In other words, the maximum value must not be less than the minimum value.

Analog Output (AO2)

24. "AO2 ANALOG RAMP"

- AO2** Default: OFF
 Range: CO-r, OFF, Hr1, Cr1, Hu

Select the desired ramp from the available options. The  symbol indicates that the fan output will be activated according to the demand.

If you selected **OFF**, go to Step 27 "AO3 Analog Ramp".

Changeover Ramp



OFF



Heat Ramp 1

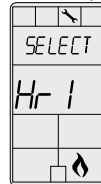

Cool Ramp 1

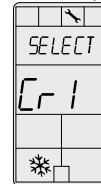

Humidity

25. "MIN VDC ANALOG AO2 OUTPUT"

- AO2** Default: 0.0 Volt
 Range: 0.0 to 10.0 Volts
 Increment: 0.1 Volt

This option does not appear if the signal ramp for AO2 is set to **OFF** (Step 24 "AO2 Analog Ramp"). Select the desired minimum voltage ("zero" value) for the AO2 ramp. The minimum value is restricted by the maximum value (Step 26 "Max Vdc Analog AO2 Output"). In other words, the minimum value must be less than the maximum value.

26. "MAX VDC ANALOG AO2 OUTPUT"

- AO2** Default: 10.0 Volts
 Range: 0.0 to 10.0 Volts
 Increment: 0.1 Volt

This option does not appear if the signal ramp for AO2 is set to **OFF** (Step 24 "AO2 Analog Ramp"). Select the desired maximum voltage ("span" value) for the AO2 ramp. The maximum value is restricted by the minimum value (Step 25 "Min Vdc Analog AO2 Output"). In other words, the maximum value must not be less than the minimum value.

Analog Output (AO3)

27. "AO3 ANALOG RAMP"

 Default: OFF
 Range: COr, OFF, Hr1, Cr1, Hu

Select the desired ramp from the available options. The  symbol indicates that the fan output will be activated according to the demand.

If you selected OFF, go to Step 30 "Control Ramp Heating".

Changeover Ramp



OFF



Heat Ramp 1

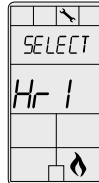

Cool Ramp 1

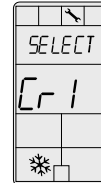

Humidity



28. "MIN VDC AO3 OUTPUT"

 Default: 0.0 Volt
 Range: 0.0 to 10.0 Volts
 Increment: 0.1 Volt

This option does not appear if the signal ramp for AO3 is set to **OFF** (Step 27 "AO3 Analog Ramp"). Select the desired minimum voltage ("zero" value) for the AO3 ramp. The minimum value is restricted by the maximum value (Step 29 "Max Vdc AO3 Output"). In other words, the minimum value must be less than the maximum value.

29. "MAX VDC AO3 OUTPUT"

 Default: 10.0 Volts
 Range: 0.0 to 10.0 Volts
 Increment: 0.1 Volt

This option does not appear if the signal ramp for AO3 is set to **OFF** (Step 27 "AO3 Analog Ramp"). Select the desired maximum voltage ("span" value) for the AO3 ramp. The maximum value is restricted by the minimum value (Step 28 "Min Vdc AO3 Output"). In other words, the maximum value must not be less than the minimum value.

Control Ramps

30. "CONTROL RAMP HEATING"

 Default: 2.0°C [4°F]
 Range: 0.5 to 5.0°C [1 to 10°F]
 Increment: 0.5°C [1°F]

Select the desired value for the heating proportional band. The heating  symbol is also displayed.

31. "CONTROL RAMP COOLING"

 Default: 2.0°C [4°F]
 Range: 0.5 to 5.0°C [1 to 10°F]
 Increment: 0.5°C [1°F]

Select the desired value for the cooling proportional band. The cooling  symbol is also displayed.

32. "CONTROL DEAD BAND HEATING"

 Default: 0.3°C [0.6°F]
 Range: 0 to 5.0°C [0 to 10.0°F]
 Increment: 0.1°C [0.2°F]

Select the desired value for the heating dead band. The heating  symbol is also displayed.



33. "CONTROL DEAD BAND COOLING"



Default: 0.3 °C [0.6°F]
Range: 0 to 5.0°C [0 to 10.0°F]
Increment: 0.1°C [0.2°F]

Select the desired value for the cooling dead band. The cooling ❄ symbol is also displayed.

Other Settings

34. "COOLING ANTI CYCLE MINUTES"



Default: 0 minutes
Range: 0 to 15 minutes
Increment: 1 minute

To protect the compressor, set the delay in minutes before activating or reactivating the cooling contact. The cooling ❄ symbol is also displayed. The cooling ❄ symbol is also displayed.

35. "ADJUST INTEGRAL TIME IN SECONDS"



Default: 0 second
Range: 0 to 250 seconds
Increment: 5 seconds

Select the desired value for the integration factor compensation.

36. "ADJUST DAMPING FACTOR SECONDS"



Default: 5 seconds
Range: 0 to 10 seconds
Increment: 1 second

Select the desired value for the damping factor. The fan 🌀 symbol and the cooling ❄ symbol are also displayed.

Fan Settings

37. "SELECT FAN SPEED SIGNAL"



Default: 3 (speed fan contact)
Range: 1 (speed fan contact), 2 (speed fan contact), 3 (speed fan contact), AnLG (Analog)

Select the desired fan speed. The fan 🌀 symbol is also displayed.

If you select the speed fan contact option (1, 2, or 3), go to Step 46, "Enable Fan Auto Mode".

38. "MIN VDC ANALOG OUTPUT FAN"



Default: 0.0 Volt
Range: 0.0 to 10.0 Volt
Increment: 0.1 Volt

This option appears only if you select **AnLG** (Analog) in step 37, "Select Fan Speed Signal". Select the desired minimum voltage (zero value) for fan ramp. The minimum value (Step 38) is restricted by the maximum value (Step 39). In other words, the minimum value must be less than the maximum value. The fan 🌀 symbol is also displayed.

39. "MAX VDC ANALOG OUTPUT FAN"



Default: 10.0 Volt
Range: 0.0 to 10.0 Volt
Increment: 0.1 Volt

This option appears only if you select **AnLG** (Analog) in step 37, "Select Fan Speed Signal". Select the desired maximum voltage (span value) for fan ramp. The maximum value (Step 39) is restricted by the minimum value (Step 38). In other words, the maximum value must be more than the minimum value. The fan 🌀 symbol is also displayed.

Go to Step 48 "Extern Sensor Temper".

40. "SELECT DO1 SIGNAL RAMP"

DO1
 Default: Cr1
 Range: COr, OFF, Hr1, Cr1, Hu

Appears only if you select 1-speed or Analog at step 37. Select the desired ramp for DO1. The  symbol indicates that the fan output will be activated according to the demand.

- Hr1: Heating Ramp 1; Cr1: Cooling Ramp 1; Hu: Humidity Ramp; COr: Changeover Ramp; OFF: No signal

If you select OFF, go to Step 48 "Extern Sensor Temper".

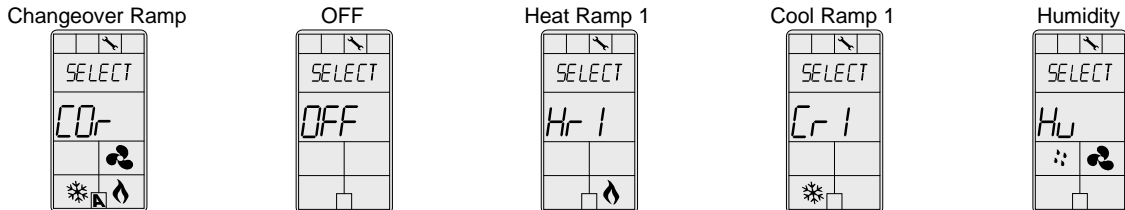
41. "SELECT DO1 CLOSE PERCENT"

DO1
 Default: CL.2 % of demand
 Range: CL.2 % to CL.9 %
 Increment: 1%

Select the percentage at which you want DO1 to close (at % of the demand of the ramp selected at Step 40 "Select DO1 Signal Ramp"). Contact automatically opens at 0% of the demand.

42. "SELECT DO1 OPEN PERCENT"

DO1
 Default: OP.0% of demand
 Range: OP.0% to TO1 closing minus 1%
 Increment: 1%

Select the percentage at which you want DO1 to open (at % of the demand of the ramp selected at Step 40 "Select DO1 Signal Ramp"). Contact automatically opens at 0% of the demand.

43. "SELECT DO2 SIGNAL RAMP"

DO2
 Default: Cr1
 Range: COr, OFF, Hr1, Cr1, Hu

Appears only if you select 1-speed or Analog at step 37, "Select Fan Speed Signal". Select the desired ramp for DO2. The  symbol indicates that the fan output will be activated according to the demand.

- Hr1: Heating Ramp 1; Cr1: Cooling Ramp 1; Hu: Humidity Ramp; COr: Changeover Ramp; OFF: No signal

If you select OFF, go to Step 48 "Extern Sensor Temper".

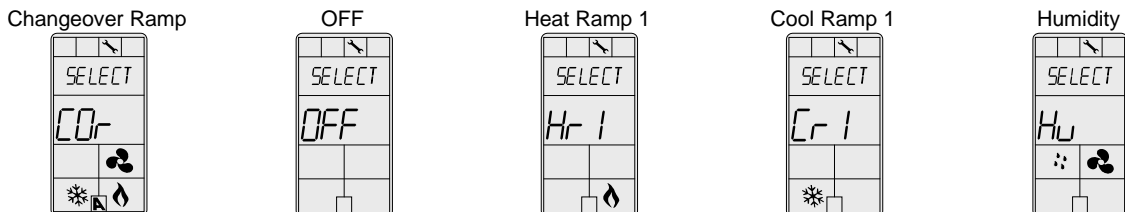
44. "SELECT DO2 CLOSE PERCENT"

DO2
 Default: CL.5 % of demand
 Range: CL.5 % to CL.9 %
 Increment: 1%

Select the percentage at which you want DO2 to close (at % of the demand of the ramp selected at Step 43, "Select DO2 Signal Ramp"). Contact automatically opens at 0% of the demand.

45. "SELECT DO2 OPEN PERCENT"

Default: OP.3% of demand
 Range: OP.0% to TO1 closing minus 1%
 Increment: 1%

Select the percentage at which you want DO2 to open (at % of the demand of the ramp selected at Step 43, "Select DO2 Signal Ramp"). Contact automatically opens at 0% of the demand.

46. "ENABLE FAN AUTO MODE"



Default: No (disable)
 Range: Yes (enable), No (disable)

Select the Enable or Disable option to allow the user to adjust the Automatic mode. The fan  symbol is also displayed.

If you selected No (disable), go to Step 48, "Extern Sensor Temper".

47. "FAN AUTO TIMEOUT MINUTES"

Default: 2 minutes
 Range: 0 to 15 minutes
 Increment: 1 minute

This option appears only if you select Yes in step 46, "Enable Fan Auto Mode". Select the desired value for the automatic shutoff delay. The fan  symbol is also displayed.

External Temperature Sensor (AI1)

48. "EXTERN SENSOR TEMPER"

Default: EtS (external temperature sensor)
 Range: OFF (internal sensor), EtS (external temperature sensor)

- In EtS mode, the thermostat is controlled by an external temperature sensor connected to AI2 (pin 13).
- Do not select OFF for this application.

If you select OFF, go to Step 50, "Select DI contact".

49. "EXTERN TEMPER SENSOR OFFSET"

Offset: Max. $\pm 5^{\circ}\text{C}$
 Range: 0.0 to 50.0°C [41.0 to 122.0°F]
 Increment: 0.1°C [0.2°F]

This option appears if you selected **EtS** (External temperature sensor) at step 48, "Extern Sensor Temper". When the temperature sensor is connected to the analog input AI2 (pin 13), the display shows the temperature read by the external temperature sensor. Adjust the offset by comparing it with a known value (for example, thermometer). If the sensor is not connected to the input or if the sensor is shorted, then the unit displays the sensor's limits.

Digital Input (DI1)

50. "SELECT DI CONTACT"

Default: NO (Normally Open)
 Range: NO (Normally Open), NC (Normally Close), OFF (not used)

Select the desired digital input contact option.

Humidity Settings (AI2)

51. "EXTERN HUMIDITY SENSOR"



Default: ON. RH% (external sensor)
Range: OFF (internal sensor), ON. RH% (external sensor)

- In ON.RH% mode, the thermostat is controlled by an external humidity sensor connected to AI1 (pin 12).
- Do not select OFF for this application.

If you select OFF, go to Step 53, "Humidity Control Ramp".

52. "EXTERN HUMIDITY SENSOR OFFSET"



Offset: ± 5%
Range: 10 to 90%
Increment: 0.1%RH

This option appears if you selected **ON.RH%** (External humidity sensor) at step 51, "Extern Humidity Sensor". When the humidity sensor is connected to the analog input AI1 (pin 12), the display shows the humidity reading by the external humidity sensor. Compare the displayed humidity percentage reading with a known value from a humidistat. This is useful for units installed in areas where the humidity read is slightly different from the room's actual humidity. For example, a humidistat placed right under the air diffuser. The humidify  symbol is also displayed. If the sensor is not connected to the input or if the sensor is shorted, then the unit displays the sensor's limits.

53. "HUMIDITY CONTROL RAMP"



Default: 5.0% RH
Range: 3 to 10% RH
Increment: 0.5% RH

Select the desired span for the humidity ramp. The humidify  symbol is also displayed.

Anti-Freeze

54. "ENABLE ANTI FREEZE PROTECT"



Default: No (disabled)
Range: No, Yes

If this option is enabled, heating starts automatically when the temperature drops to 4°C [39°F], even if the thermostat is in OFF mode. Once the temperature reaches 5°C [41°F], the heating stops.

Operation Mode



Set the Mode Selector Jumper (JP3) to the "RUN" mode (Operation Mode).
 Refer to Wiring on page 18.

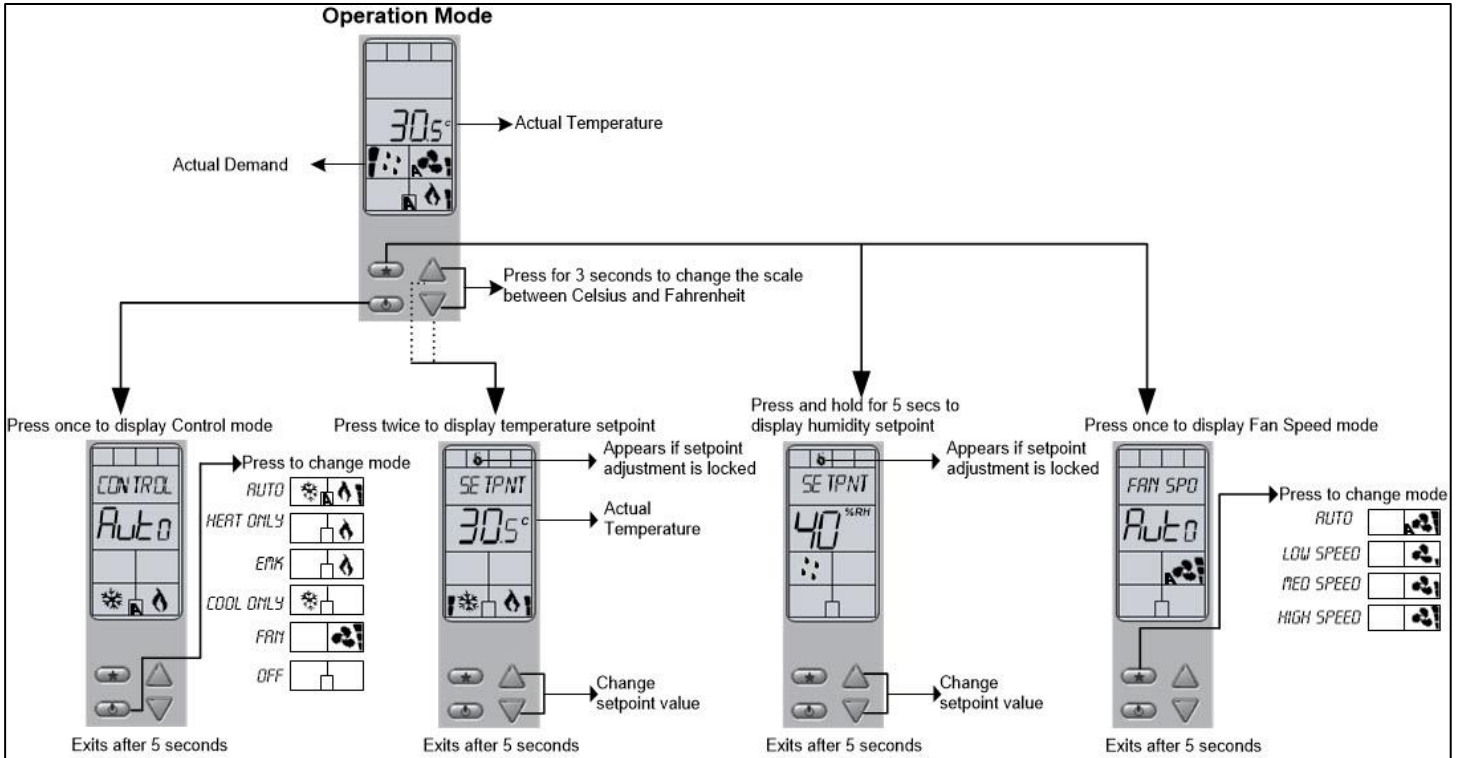

Power Up

Upon power up, the LCD illuminates, all segments appear for 2 seconds, and then the screen displays the unit's version for 2 seconds.

LCD Backlight

Press any key on the thermostat to illuminate the LCD for 4 seconds.



Temperature and Humidity

The thermostat displays the temperature reading for 8 seconds and then displays the humidity reading for 2 seconds. If the sensor is disconnected or short-circuited, then the unit displays the sensor's limits. To toggle the temperature scale between °C and °F, press both the Up Δ and Down ∇ arrow keys for 3 seconds.

Temperature Setpoint

Press the Up Δ or Down ∇ arrow keys twice to display the temperature setpoint for 5 seconds. To adjust the setpoint, press the arrow keys while the temperature is displayed. If the setpoint adjustment is locked (Step 4), then the lock θ symbol appears. The unit automatically saves any changed values.

Humidity Setpoint

Press and hold the  button for 5 seconds to display the humidity setpoint for 5 seconds. To adjust the setpoint, press the Up  and Down  arrow keys while the setpoint is displayed. The unit automatically saves any changed values.

Control Mode

To access the Control Mode, press the  key. The Control Mode appears for 5 seconds. These options can vary depending on the options selected at Steps 6, “Adjust Temper Control Mode” and 7, “Enable On Off Control Mode” on page 21.

- Auto (Automatic Cooling or Heating)
- Cooling only (on)
- Heating only (on)
- Fan only
- OFF

Fan Speed Selection Mode

To access the Fan Speed selection mode, press the  key. The Fan Mode appears for 5 seconds. These options can vary depending on the fan speed signal and auto mode settings at Step 37, “Select Fan Speed Signal” and Step 46, “Enable Fan Auto Mode” on page 26.

- Automatic speed. This option is available if you have selected **Yes** (Enable) at Step 46, “Enable Fan Auto Mode”.
- Low speed
- Medium speed
- High speed

Start-up Procedure

We recommend following this start-up procedure given below to avoid any anomaly resulting from wrong cleaning of the components:

- Ensure that the mechanical, electric, and plumbing connections are properly made and secured.
- Verify that there are no leaks in the water supply connections.
- Verify that there are no leaks in the drain connection.
- Verify operation of the three speeds or modulation of the fan.
- Ensure that the electrical connection tightening is correct.
- Ensure that the condition of internal fuses is good.
- Verify the resistance of each circuit against the ground.
- Verify the correct operation of contactor(s).

Service

Heater – General Maintenance

Neptronic's electric heater, which is part of a complete Hot Yoga Studio system with ventilation, heating, and humidification does not require any specific maintenance. However, we recommend a yearly inspection, typically before winter season or after a long-term shutdown.

Maintenance

Visual Inspection



WARNING: Risk of electric shock. Shut down the electric supply to the heater before commencing visual inspection.

- Verify that the heating element is in excellent condition.
- Ensure that the heating element is clean, free of dust or lint.
- Ensure that there is no dust accumulation on the Open Coil. Any dust or lint accumulation can lead to fire hazard.
- Verify any indication of overheating condition (discoloration) as well as any trace of oxidation (rust).

Electrical Inspection



WARNING: Risk of electric shock. Shut down the electric supply to the heater before commencing electrical inspection.

- Ensure that the electrical connection tightening is correct.
- Ensure that the condition of internal fuses is good.
- Verify the resistance of each circuit against the ground.
- Verify the correct operation of contactor(s).

If necessary, the electrical component is to be replaced only with the identical original component.

Replace Air Filters and UV Lamp



ATTENTION: Turn off power to the ballast before servicing the UV light



WARNING: UV light hazard. Harmful to bare skin and eyes. Can cause temporary or permanent loss of vision. Never look at the lamp while illuminated.



MERCURY NOTICE: This device contains mercury in the sealed UV lamp. Do not place your used lamp in the trash. Dispose of it appropriately. Broken lamp cleanup: Do not use a household vacuum. Sweep debris into a plastic bag and dispose of appropriately. Contact your local waste management authority for instructions regarding recycling and the proper disposal of UV lamps.



CAUTION: UV light hazard. Harmful to bare skin. Can cause severe burns. Disconnect power and wait 15 minutes before servicing the lamp.

CAUTION: Breakable glass hazard. Be careful when removing/replacing the lamp. Wear protective gloves when handling bulb.



Note: Replace the UV-C lamps annually. While there still may be a visible blue light, this is not an indication of UV-C output. Note that the UV-C wavelength is invisible. Contact your local UV Resources™ distributor or visit www.UVResources.com. The UV lamp manufacturer model number is SEF-12-SO-24V-1.

Humidifier – General Maintenance

The humidifier, which is part of a complete Hot Yoga Studio system with ventilation, heating, and humidification, requires a service after it reaches the specified service hours. A message is displayed when the humidifier service is due. The routine service includes a cleaning of the evaporation chamber. We recommend setting the service demand depending on the water quality, the frequency of automatic drain cycles, and the demand placed on the humidifier. The manual cleaning frequency can range from every 2 months to once a year.

Cleaning the Evaporation Chamber



WARNING: Risk of burning. The evaporation chamber and its contents can be extremely hot. Check the temperature before handling the humidifier.

Follow the sequence while cleaning the evaporation chamber.

Allow the Evaporation Chamber to Cool Down

1. Set the front panel switch AUTO/OFF/DRAIN to DRAIN. The humidifier will command a drain cycle.
2. Ensure that the evaporation chamber is empty. When it is empty, set the front panel switch AUTO/OFF/DRAIN to AUTO, the evaporation chamber will be filled with cool water; the FILL light will be illuminated.
3. As soon as the evaporation chamber is full of cool water, the FILL light will extinguish, Set the front panel switch AUTO/OFF/DRAIN to DRAIN again.
4. At the end of this drain cycle, check the temperature of the evaporation chamber. To do so, open the front door of the humidifier and touch the evaporation chamber with the back of your hand, if it is cool enough you can shut down the electrical supply. If not, repeat the cooldown operation until it is cool enough.
5. Set the front panel switch AUTO/OFF/DRAIN to OFF.

Shut down the Electrical Supply



Caution: Risk of electric shock. Turn off the electric supply of the humidifier.

- Turn off the main power supply to the humidifier.

Disconnect Heating Element(s)

Remove the high voltage connector located at the top right-hand side of the mechanical compartment.

- Model HVH6 and HVH7 - Unscrew the connector.
- Model HVH10 and HVH12 - Squeeze the locking ears of the high voltage connector and pull it apart.

Disconnect the Other/Third-party Accessories

- Disconnect the connector from the water level sensor; this connector is attached to a cable that enters the mechanical compartment just below the high voltage connector. Squeeze the locking ear of the connector and pull it apart.
- Remove the connection to the high limit temperature switch (klixon), located on the top cover of the evaporation chamber.

Disconnect the Steam Hose and Water Pipe

- Remove the steam hose(s) at the top of the evaporation chamber.
- Remove the water drain/fill connection to the evaporation chamber. To do this, unscrew the nipple located on the lower right-hand side of the evaporation chamber.

Remove the Evaporation Chamber

The evaporation chamber may now be removed from the humidifier cabinet.



The evaporation chamber still contains 1 inch of water, ensure that you do not spill this water on yourself.

Ensure that your footing is secure when lifting out the evaporation chamber. Large humidifiers may weigh more than 35 lb (15 Kg). This operation may also require the assistance of another person.

Open the Evaporation Chamber

- Remove the cover from the evaporation chamber.
 - Model HVH6 and HVH7: Disengage the 3 latches located around the evaporation chamber. Note that these latches are very tight, we recommend you to use a screwdriver or pliers to do this.
 - Model HVH10 and HVH12: Disengage the 4 latches located around the evaporation chamber.
- Remove the cover from the evaporation chamber.

Clean the Evaporation Chamber

- Pour out any remaining water and scale that is on the bottom of the container.
- To clean out the remaining scale from the container, use a stiff brush (synthetic filament only) and some vinegar or any weak acid for cleaning stainless steel.



If the amount of scale to remove is high, the service demand frequency is too low for the quality of supply water. The service demand frequency must be adjusted accordingly. Too much scale may impair the normal operation of the humidifier or damage it; in this case, warranty will be void.

Clean the Other Components

- The components installed on the cover (heating element and water level sensor) and the cover itself are to be cleaned as necessary, if some scaling is accumulated on them.
- Proceed as per the cleaning of the container.
- Removing and cleaning of the water level sensor. A chamber protects the water level sensor. Cleaning of the sensor requires removing this chamber.
 - Unscrew the 2 screws holding the chamber, located on the cover.
 - Carefully remove the chamber, do not touch or damage the water level sensor.
 - Clean out the water level sensor by using a clean soft cloth.



Caution: The water level sensor is covered by a thin layer of Teflon, any scratch or damage to this layer of Teflon may cause failure of the humidifier.

- Clean the chamber by proceeding as per the main container.
- Re-attach the clean chamber to the cover and screw in the 2 screws on the top of the cover.

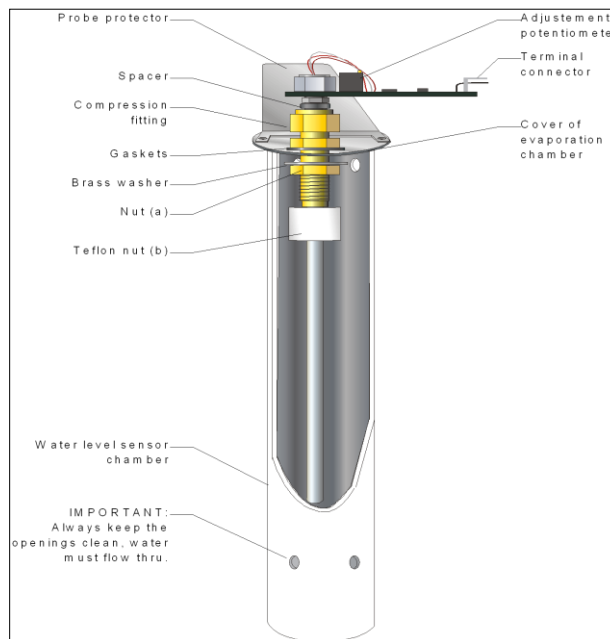

Illustration 7 - Cleaning the Evaporation Chamber

Reassemble the Evaporation Chamber

- Rinse out the container and the cover with water.
- Check the cover gasket, and make sure that the gasket is placed properly before re-installing the cover on the container. The water level sensor must be in front of the drain/fill connection of the evaporation chamber.
- Tighten the latches around the cover (3 or 4).
- Replace the evaporation chamber in the humidifier.
- Tighten the water drain/fill connection nipple.
- Replace the steam hose(s) on the outlet of the evaporation chamber.
- Reconnect the connector of the water level sensor, high-temperature switch (klixon) and the high voltage connector of the heating element.



Caution: Ensure that the high voltage connector is locked properly. An improper connection may provoke electric arcs.



Start the Humidifier

- Turn on the main power supply to the humidifier. Illuminates the POWER light on the front panel.
- Press the  button to enter the programming mode, to reset the Running hours (see Step 2 Running 0645 Hrs, Programming Mode).
- Set the front panel switch AUTO/OFF/DRAIN to AUTO. The humidifier will command to fill the evaporation chamber with water; the FILL light must be illuminated. It is possible that the CHECK light will illuminate because the evaporation chamber is empty. This signal will extinguish as soon as the normal condition is reached. If there is a humidity demand, the humidifier will produce steam again.

Wiring

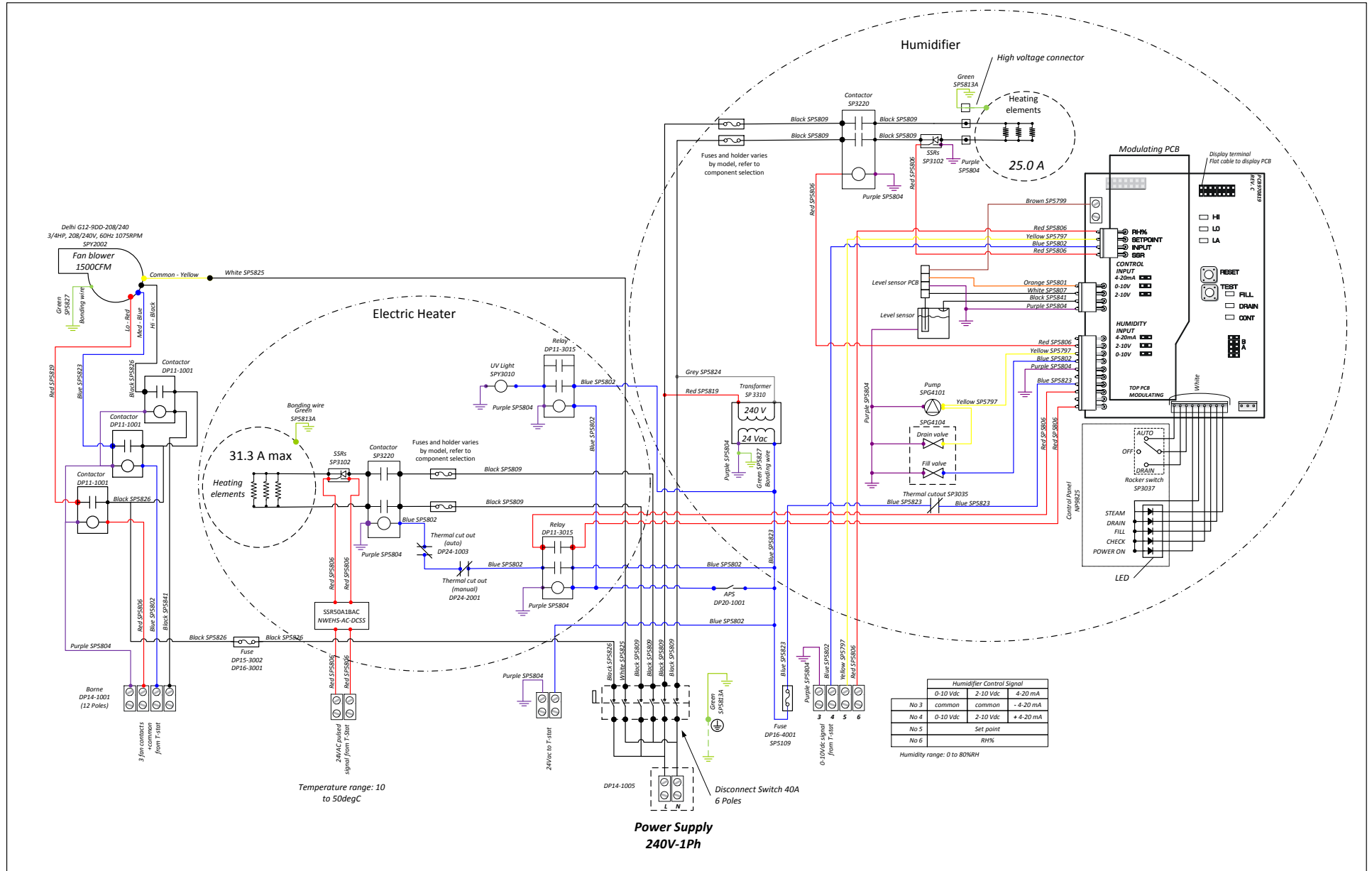

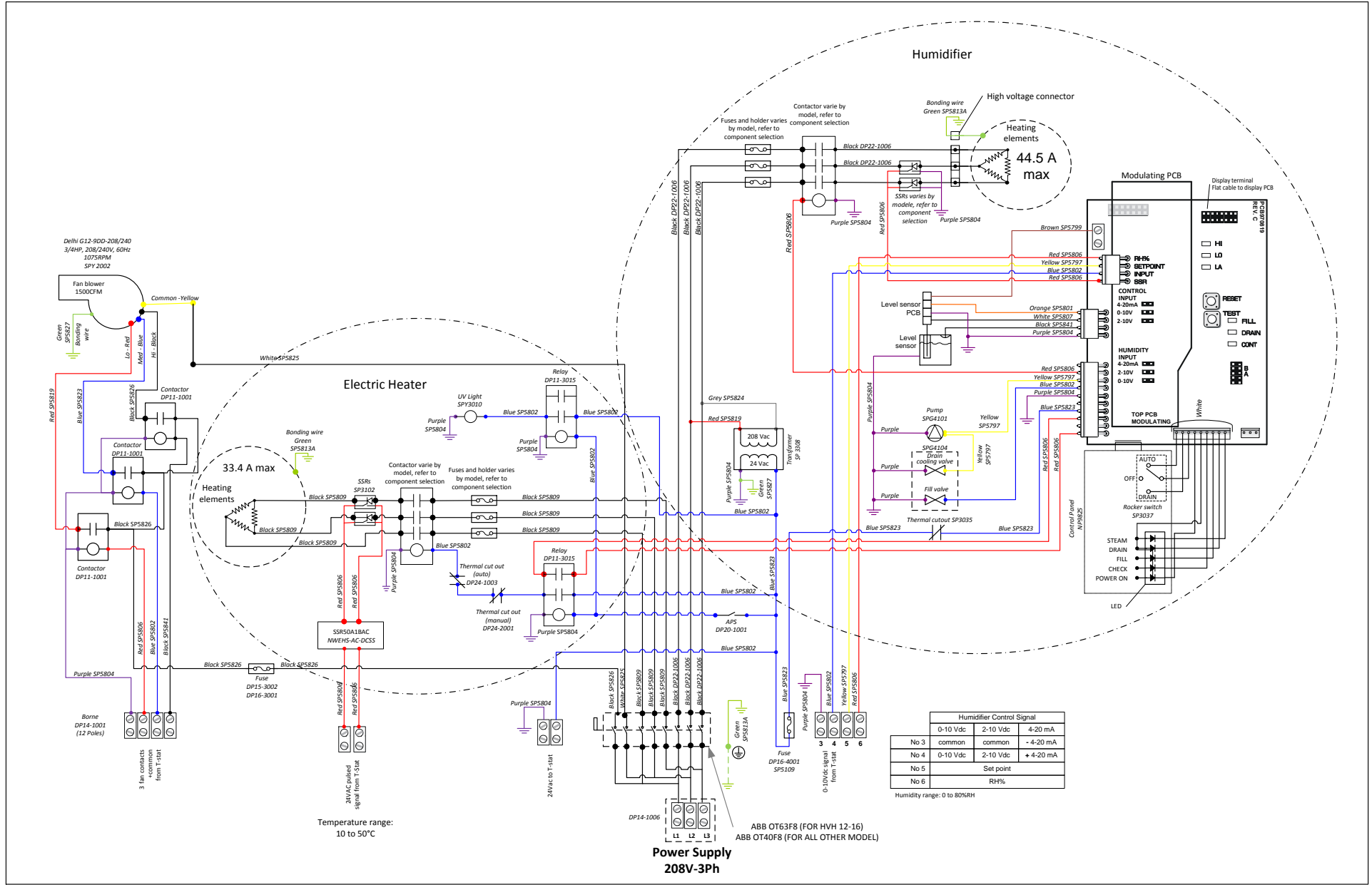



neptronic®

400 Lebeau blvd, Montreal, Qc, H4N 1R6, Canada

www.neptronic.com

Toll-free in North America: 1-800-361-2308

Tel.: (514) 333-1433

Fax: (514) 333-3163

Customer service fax: (514) 333-1091

Monday to Friday: 8:00am to 5:00pm (Eastern Time)