

### Model

**TFCB24F3XYZ1**

with BACnet Communication

### Description

The TFCB24F3XYZ1 is a fully configurable controller designed specifically for 2 pipe and 4 pipe fan coil applications. No additional modules are required as the required inputs, outputs and control algorithms are built into the unit. The TFCB24F3XYZ1 also provides support for networked communications via the BACnet MS/TP protocol.

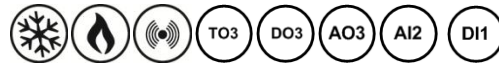

**TFCB24F3XYZ1**

### Applications

- Heating, cooling and reheat
- 2 pipes or 4 pipes
- Auxiliary heating sources, such as electric baseboards, can also be applied

### Features

- Backlit LCD with simple icon and text driven menus
- Configurable inputs and outputs
- 2 Pipes with Analog, ON/OFF, or Floating option
- 4 Pipes with Analog, ON/OFF, or with local reheat function
- Precise temperature control with programmable PI function
- Selectable Fahrenheit or Celsius scale
- Independent cool and heat setpoint for No Occupancy
- Lockable setpoint, control mode, and fan mode
- Selectable internal or external temperature sensor
- Changeover by contact or external temperature sensor
- Selectable proportional control band and dead band
- Anti-freeze protection
- BACnet<sup>®</sup> MS/TP @ 9600, 19200, 38400, or 76800 bps
  - Selectable MAC address
  - Automatic or manual device instance assignment
  - Automatic baud rate detection
  - Copy and broadcast configuration to other networked TFCB24F3XYZ1 modules

### Typical Application

Fan coil applications provide heating and cooling to a zone by circulating hot and cold air depending on the demand to maintain an optimum temperature in the selected space. A fan coil setup typically consists of fan coil units, source for hot and cold water, and a pipe system for distribution. When there is a demand for heating, the hot water is supplied to the unit through the source and passes over the heating coil, and the hot air is pushed into the zone by the fan. When there is a demand for cooling, the cold water is supplied to the unit through the source and passes over the cooling coil, and the cold air is pushed into the zone by the fan.

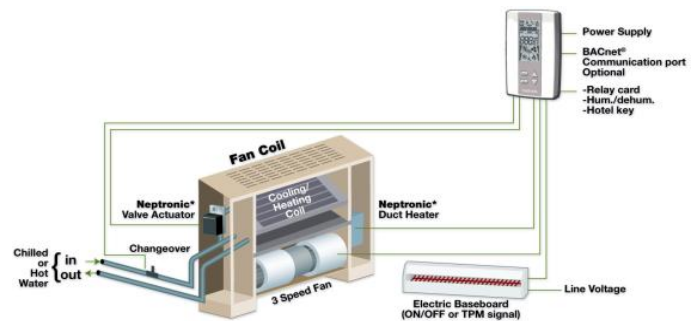

\* Consult [www.neptronic.com](http://www.neptronic.com) for details on these Neptronic products.



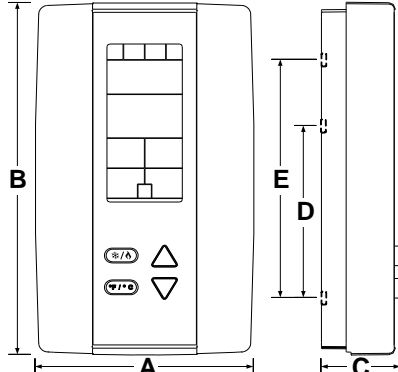



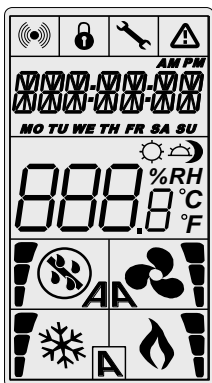

### Technical Specifications

Description	Fan Coil Thermostat Controller
Inputs	1 Digital input (24Vac or dry contact) 1 Analog input (external temperature sensor 10Kohms) 1 Analog input (change over 10Kohms or dry contact)
Outputs	1 Fan analog or 3 Fan speed dry contracts 24Vac, 1A max 3A in-rush 2 Analog outputs (cooling and/or heating 0 to 10Vdc) 1 Analog output (local reheat 0 to 10Vdc) 2 TRIAC outputs (cooling and/or heating) 24Vac, 0.3A max fused/TRIAC 1 TRIAC output (local reheat) 24Vac, 0.3A max fused/TRIAC
Power Supply	22 to 26Vac 50/60Hz
Power Consumption	1VA max
Setpoint Range	10°C to 40°C [50°F to 104°F]
Control Accuracy	Temperature: ±0.4°C [0.8°F]
Proportional Band	0.5°C to 5°C [1°F to 10°F] adjustable (heat/cool/reheat independent)
Dead Band	0.3°C to 5°C [0.6°F to 10°F] adjustable (heat/cool/reheat independent)
Electrical Connection	0.8 mm <sup>2</sup> [18 AWG] minimum
Operating Temperature	0°C to 50°C [32°F to 122°F]
Storage Temperature	-30°C to 50°C [-22°F to 122°F]
Relative Humidity	5 to 95% RH non condensing
Degree of Protection of Housing	IP 30 (EN 60529)
Weight	160 g. [0.36 lb]
Dimensions A = 2.85"   73mm B = 4.85"   123mm C = 1.00"   24mm D = 2.36"   60mm E = 3.27"   83mm	

### Interface



#### Symbols on Display

	Cooling ON A: Automatic		Communication Status		Alarm status
	Heating ON A: Automatic		Menu set-up Lock		Energy saving mode
	Fan ON A: Automatic		Programming Mode (Technician setting)		°C: Celsius scale °F: Fahrenheit scale

### Wiring

We strongly recommend that all Neptronic products be wired to a separate grounded transformer and that transformer shall service only Neptronic products. This precaution will prevent interference with, and/or possible damage to incompatible equipment.

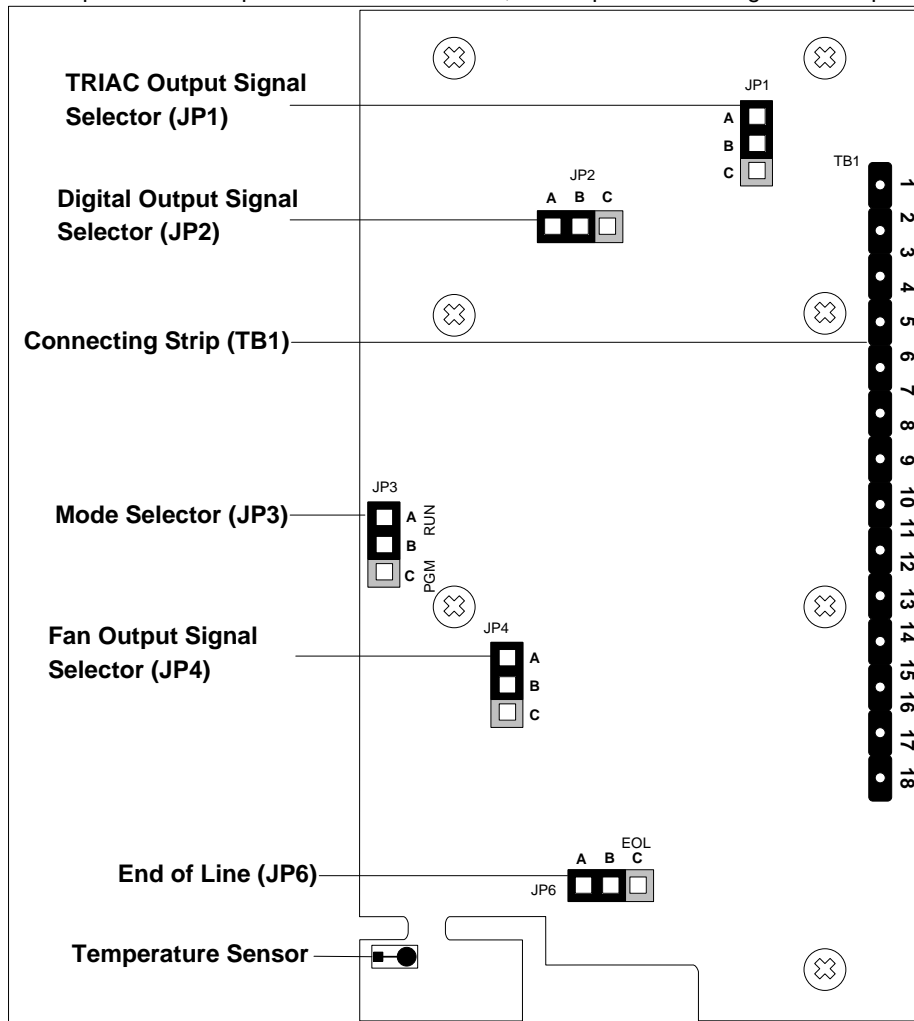

### Wiring - 2 Pipe Terminal Description Details - 2 Pipe

For 2 pipe signal configuration, refer to step 9 on page 6.  
For fan output configuration, refer to step 33 on page 10.

Terminals		Analog				On/Off				Floating				Step
1	Common	Common				Common				Common				-
2	24 Vac	24 Vac				24 Vac				24 Vac				-
3	Common TRIAC	Common TRIAC				Common TRIAC				Common TRIAC				
4	TRIAC Output 1 (TO1)	-				2 pipe on/off				2 pipe floating (close)				9
5	TRIAC Output 2 (TO2)	-				-				2 pipe floating (open)				9
6	TRIAC Output 3 (TO3)	Local reheat *				Local reheat *				Local reheat *				21
<b>Fan</b>		<b>1 speed</b>	<b>2 speed</b>	<b>3 speed</b>	<b>Analog</b>	<b>1 speed</b>	<b>2 speed</b>	<b>3 speed</b>	<b>Analog</b>	<b>1 speed</b>	<b>2 speed</b>	<b>3 speed</b>	<b>Analog</b>	
7	Common Relay	Common Relay				Common Relay				Common Relay				
8	Digital Output 1 (DO1)	-	-	High	-	-	-	High	-	-	-	High	-	33
9	Digital Output 2 (DO2)	-	High	Med	-	-	High	Med	-	-	High	Med	-	33
10	Digital Output 3 (DO3)	Low	Low	Low	AO4	Low	Low	Low	AO4	Low	Low	Low	AO4	33
11	Digital Input 1 (DI1)	Occupancy Sensor *				Occupancy Sensor *				Occupancy Sensor *				
12	Analog Input (AI1)	External Temp Sensor *				External Temp Sensor *				External Temp Sensor *				38
13	Analog Input (AI2)	External Changeover *				External Changeover *				External Changeover *				13
14	Analog Output 1 (AO1)	2 pipe analog				-				-				9
15	Analog Output 2 (AO2)	-				-				-				9
16	Analog Output 3 (AO3)	Local reheat *				Local reheat *				Local reheat *				21
17	A+	BACnet communication				BACnet communication				BACnet communication				-
18	B-	BACnet communication				BACnet communication				BACnet communication				-

\* optional

### Wiring - 4 Pipe Terminal Description Details - 4 Pipe

For 4 pipe signal configuration, refer to step 15 and 18 on page 7.

For fan output configuration, refer to step 33 on page 10.

Terminals	Cool: Analog Heat: Analog	Cool: On/Off Heat: On/Off	Cool: Analog Heat: On/Off or Pulse	Cool: On/Off Heat: Analog	Step
1 Common	Common	Common	Common	Common	-
2 24 Vac	24 Vac	24 Vac	24 Vac	24 Vac	-
3 Common TRIAC	Common TRIAC	Common TRIAC	Common TRIAC	Common TRIAC	-
4 TRIAC Output 1 (TO1)	-	4 pipe cool (on/off)	-	4 pipe cool (on/off)	9
5 TRIAC Output 2 (TO2)	-	4 pipe heat (on/off or pulse)	4 pipe heat (on/off or pulse)	-	9
6 TRIAC Output 3 (TO3)	Local reheat *	Local reheat *	Local reheat *	Local reheat *	21
<b>Fan</b>	<b>1 speed</b> <b>2 speed</b> <b>3 speed</b> <b>Analog</b>	<b>1 speed</b> <b>2 speed</b> <b>3 speed</b> <b>Analog</b>	<b>1 speed</b> <b>2 speed</b> <b>3 speed</b> <b>Analog</b>	<b>1 speed</b> <b>2 speed</b> <b>3 speed</b> <b>Analog</b>	
7 Common Relay	Common Relay	Common Relay	Common Relay	Common Relay	
8 Digital Output 1 (DO1)	- - High -	- - High -	- - High -	- - High -	33
9 Digital Output 2 (DO2)	- High Med -	- High Med -	- High Med -	- High Med -	33
10 Digital Output 3 (DO3)	Low Low Low AO4	Low Low Low AO4	Low Low Low AO4	Low Low Low AO4	33
11 Digital Input 1 (DI1)	Occupancy Sensor *	Occupancy Sensor *	Occupancy Sensor *	Occupancy Sensor *	
12 Analog Input (AI1)	External Temp Sensor *	External Temp Sensor *	External Temp Sensor *	External Temp Sensor *	-
13 Analog Input (AI2)	-	-	-	-	13
14 Analog Output 1 (AO1)	4 pipe cool (analog)	-	4 pipe cool (analog)	-	18
15 Analog Output 2 (AO2)	4 pipe heat (analog)	-	-	4 pipe heat (analog)	15
16 Analog Output 3 (AO3)	Local reheat (analog)*	Local reheat (analog)*	Local reheat (analog)*	Local reheat (analog)*	21
17 A+	BACnet communication	BACnet communication	BACnet communication	BACnet communication	-
18 B-	BACnet communication	BACnet communication	BACnet communication	BACnet communication	-

\* optional

### Jumpers

Jumpers	Description
JP1 TRIAC Output Signal Selector	A&B = Internal: All TRIAC output signals are linked to internal 24 Vac (same as thermostat). B&C = External: All TRIAC output signals are linked to external 24 Vac (different than thermostat).
JP2 Digital Output Signal Selector	A&B = Internal: All digital output signals are linked to internal 24 Vac (same as thermostat). B&C = External: All digital output signals is linked to external 24 Vac (different than thermostat).
JP3 Mode Selection	A&B = RUN: Thermostat is in Operation Mode. (See Operation Mode, page 14) B&C = PGM: Thermostat is in Programming Mode. (See Programming Mode, page 5)
JP4 Fan Output Signal Selection	A&B: Pin 10 of TB1 is set to digital output signal (DO3). (See Step 33) B&C: Pin 10 of TB1 is set to analog output signal (AO4). (See Step 33)
JP6 End of Line	A&B: No End of Line. B&C: 120 Ohm End of Line (on the last TFCB24F3XYZ1 of the RS-485 communication bus).

### Mounting Instructions

**CAUTION:** Remove power to avoid a risk of malfunction.

- Remove the captive screw that's holding the base and the front cover of the unit together.
- Lift the front cover of the unit to separate it from the base.
- Pull all wires through the holes in the base.
- Secure the base to the wall using wall anchors and screws (supplied). Make the appropriate connections.
- Mount the control module on the base and secure using the screw.

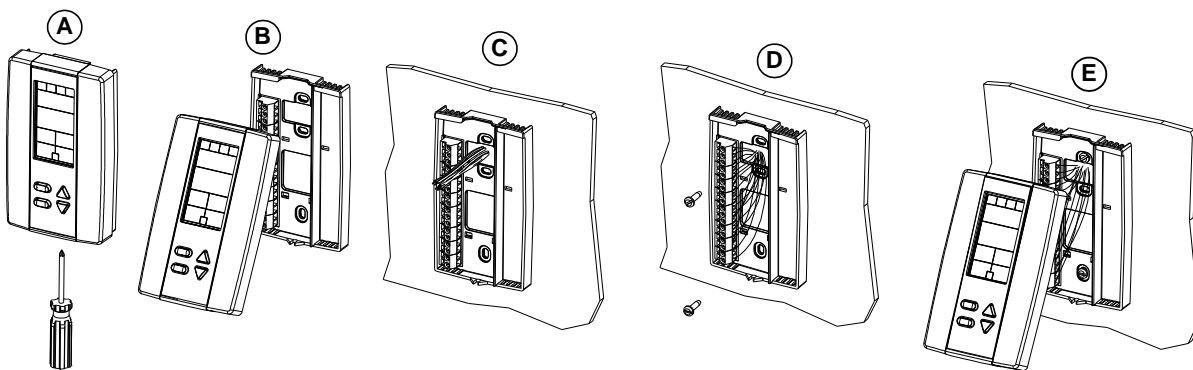







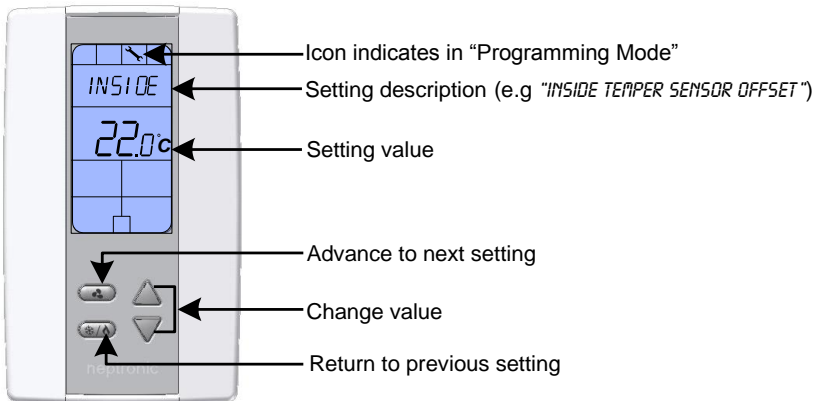



### Programming Mode



The Mode Selector Jumper JP3 must be set to the "PGM" mode (Programming Mode). Refer to Wiring on page 2. To exit, set the Jumper JP3 back to the "RUN" mode (Operation Mode). All changes will be saved.



### Symbols used in this Manual

Icon	Description	Icon	Description	Icon	Description	Icon	Description
	Temperature		Heating		Cooling		BACnet Communication
	Fan Coil		Fan		Pipe		Analog Output 1
	Occupancy		Time				

### Setpoint and User Control

#### 1. "INSIDE TEMPER SENSOR OFFSET"



Range: 10.0°C to 40.0°C [50°F to 104.0°F]  
 Offset: Max. ± 5°C  
 Increment: 0.1°C [0.2°F]

Compare the displayed temperature reading with a known value from a thermometer. To offset or calibrate the sensor, use the arrows button to set the desired temperature reading. This is useful for thermostats installed in areas where the temperature read is slightly different than the room's actual temperature. For example, a thermostat placed right under the air diffuser. If the thermostat is set to use an external temperature sensor, (**t10.0** at Step 38), the thermostat displays "OFF".

#### 2. "ADJUST MINIMUM USER SETPNT"



Default: 15.0°C [59°F]  
 Range: 10.0°C to 40.0°C [50°F to 104°F]  
 Increment: 0.5°C [1°F]

In Operation mode, you cannot decrease the setpoint to less than the value that is set as the minimum user point. The minimum value is restricted by the maximum value set at Step 3. In other words, the value that is set as the minimum cannot be greater than the maximum value.

#### 3. "ADJUST MAXIMUM USER SETPNT"



Default: 30.0°C [86°F]  
 Range: 10.0°C to 40.0°C [50°F to 104°F]  
 Increment: 0.5°C [1°F]

In Operation mode, you cannot increase the setpoint to more than the value that is set as the maximum user point. The maximum value is restricted by the minimum value set at Step 2. In other words, the value that is set as the maximum cannot be less than the minimum value.

#### 4. "USER SETPNT LOCKED"



Default: No (Unlocked)  
Range: Yes (Locked)/No (Unlocked)

If set to No, the user setpoint option is not locked and the user can adjust the desired setpoint temperature. If set to Yes, the user setpoint option is locked and the user cannot set the desired setpoint temperature. A lock symbol  appears indicating that the setpoint is locked.

#### 5. "ADJUST INTERN SETPNT"





Default: 22.0°C [72°F]  
Range: 10.0°C to 40.0°C [50°F to 104°F]  
Increment: 0.5°C [1°F]

Set the desired temperature setpoint within the defined range. If the setpoint option was locked in Step 4, a lock symbol  is displayed. The setpoint value is restricted by the minimum (Step 2) and maximum (Step 3) values. In other words, the setpoint should be within in the range of minimum and maximum setpoints.

#### 6. "ADJUST TEMPER CONTROL MODE"



Default: Auto (Automatic)  
Range: Auto (Automatic Cooling and Heating), ON (Cooling or Heating), Heat (Heating Only), Cool (Cooling Only)

Select the control mode that you want to authorize to the user. To authorize all the available modes, select Auto (Automatic Mode). The cooling  and heating  symbols are also displayed.

#### 7. "ENABLE ON OFF CONTROL MODE"



Default: Yes (Enable)  
Range: Yes (Enable)/No (Disable)

If you select Yes, the user can set the unit to "Off" via the Control Mode (see page 15). If you select No, the "Off" selection does not appear in the Control Mode.

## Pipe System Selection

#### 8. "SELECT 2 PIPE 4 PIPE SYSTEM"



Default: 2P (2 pipe)  
Range: 2P (2 pipe)/4P (4 pipe)



Select the number of pipes that you want to use.

**If you selected the 4 pipes option, go to Step 15.**

#### 9. "SELECT 2 PIPE SIGNAL"



Default: AnLG (Analog)  
Range: AnLG (Analog), OnOf (On/Off), Flt (Floating)

Select the desired signal output for your 2 pipe system from the available options. The cooling  and heating  symbols are also displayed.

- If you select analog signal, AO1 will be set to automatic heat/cool changeover.
- If you select OnOf, TO1 will be set to automatic heat/cool changeover.
- If you select Flt, TO1 will be set to close and TO2 will be set to open.

**If you selected AnLG (analog) signal, go to Step 11.**

**If you selected OnOf (on/off) signal, go to Step 13.**

#### 10. "SET FLOATING TIME IN SECONDS"



Default: 100 seconds  
Range: 15 to 250 seconds  
Increment: 5 seconds

Select the desired value for the floating time signal and go to Step 13.

### Outputs

#### 11. "MIN VDC ANALOG OUTPUT"



Default: 0.0 Volt  
 Range: 0.0 to 10.0 Volt  
 Increment: 0.1 Volt

Select the desired minimum voltage (zero value) for the analog ramp. The minimum value (Step 11) is restricted by the maximum value (Step 12). In other words, the minimum value should be less than the maximum value.

#### 12. "MAX VDC ANALOG OUTPUT"



Default: 10.0 Volt  
 Range: 0.0 to 10.0 Volt  
 Increment: 0.1 Volt

Select the desired maximum voltage (span value) for the analog ramp. The maximum value (Step 12) is restricted by the minimum value (Step 11). In other words, the maximum value should be greater than the minimum value.

#### 13. "CH OVER TEMPER SENSOR"



Default: SENs (External Changeover Sensor)  
 Range: SENs, NoCl, NoHt

- If SENs is selected: heating mode activates when the temperature read by the external sensor is above the Changeover Setpoint and cooling mode activates when the temperature read by the external sensor is below the Changeover Setpoint. (see Step 14)
- If NoHt is selected: heating mode activates if the contact is opened and the cooling mode activates if the contact is closed. (see Step 14)
- If NoCl is selected: heating mode activates if the contact is closed and cooling mode activates if the contact is open.

If you selected NoCl or NoHt option, go to Step 21.

#### 14. "CH OVER SETPNT TEMPER"



Default: 24.0°C [75°F]  
 Range: 10.0°C to 40.0°C [50°F to 104°F]  
 Increment: 0.5°C [1°F]

This option appears if you have set one of the analog inputs to **SENs** (External Changeover Sensor) at Step 13. Set the desired changeover temperature setpoint. Note that the heating mode activates when the temperature read by the external sensor is above the changeover setpoint and cooling mode activates when the temperature read by the external sensor is below the changeover setpoint.

Go to Step 21.

#### 15. "SELECT 4 PIPE HEATING SIGNAL"



Default: AnLG (Analog)  
 Range: AnLG (Analog), OnOf (On/Off), PULs (Pulse)

This option appears if you have selected **4P** at Step 8. Select the heating signal for your 4 pipe system.

- If you select AnLG (Analog), AO2 will be set to heating.
- If you select OnOf (On/Off), or PULs (Pulse), TO2 will be set to heating.

If you selected OnOf or PULs signal, go to Step 18.

#### 16. "MIN VDC ANALOG OUTPUT HEATING"



Default: 0.0 Volt  
 Range: 0.0 to 10.0 Volt  
 Increment: 0.1 Volt

Select the desired minimum voltage (zero value) for heating ramp. The minimum value (Step 16) is restricted by the maximum value (Step 17). In other words, the minimum value must be less than the maximum value.

#### 17. "MAX VDC ANALOG OUTPUT HEATING"



Default: 10.0 Volt  
 Range: 0.0 to 10.0 Volt  
 Increment: 0.1 Volt

Select the desired maximum voltage (span value) for heating ramp. The maximum value (Step 17) is restricted by the minimum value (Step 16). In other words, the maximum value must be greater than the minimum value.

### 18. "SELECT 4 PIPE COOLING SIGNAL"



Default: AnLG (Analog)  
Range: AnLG (Analog), OnOf (On/Off)

This option appears if you have selected **4P** at Step 8. Select the desired cooling signal output for your 4 pipe system.

- If you select the *AnLG (analog) signal*, *AO1* will be set to cooling.
- If you select the *OnOf (on/off) signal*, *TO1* will be set to cooling.

If you selected the **OnOf** signal, go to **Step 21**.

### 19. "MIN VDC ANALOG OUTPUT COOLING"



Default: 0.0 Volt  
Range: 0.0 to 10.0 Volt  
Increment: 0.1 Volt

Select the desired minimum voltage (zero value) for cooling ramp. The minimum value (Step 19) is restricted by the maximum value (Step 20). In other words, the minimum value must be less than the maximum value.

### 20. "MAX VDC ANALOG OUTPUT COOLING "



Default: 10.0 Volt  
Range: 0.0 to 10.0 Volt  
Increment: 0.1 Volt

Select the desired maximum voltage (span value) for cooling ramp. The maximum value (Step 20) is restricted by the minimum value (Step 19). In other words, the maximum value should be greater than the minimum value.

### 21. "SET LOCAL REHEAT SIGNAL"



Default: OFF (no signal selected)  
Range: OFF, AnLG, AnLG, On/Of, On/Of, PuLS, PuLS

Select the desired signal output for reheat.

- If you select *AnLG (Analog, heating and fan)*, *AO3* will be set to reheat.
- If you select *On/Of (On/Off heating and fan)* or *PuLS (Pulse heating and fan)*, *TO3* will be set to reheat.

If you selected **On/Of (On/Off heating and fan)**, or **PuLS (Pulse heating and fan)**, go to **Step 24**.

If you selected **OFF**, go to **Step 26**.

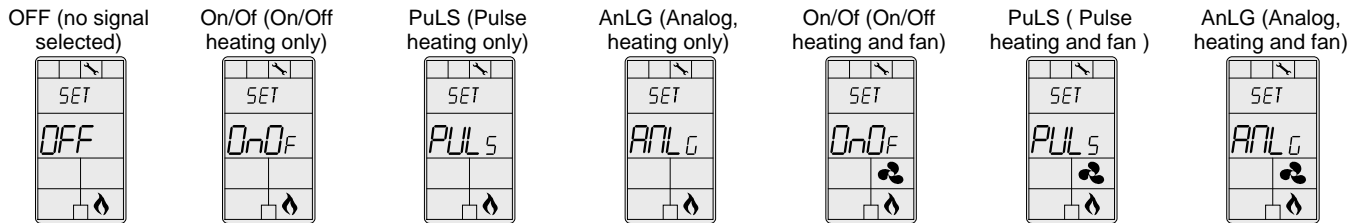

### 22. "MIN VDC ANALOG OUTPUT REHEAT"



Default: 0.0 Volt  
Range: 0.0 to 10.0 Volt  
Increment: 0.1 Volt

Select the desired minimum voltage (zero value) of reheat ramp. The minimum value (Step 22) is restricted by the maximum value (Step 23). In other words, the minimum value must be less than the maximum value.

### 23. "MAX VDC ANALOG OUTPUT REHEAT"



Default: 0.0 Volt  
Range: 0.0 to 10.0 Volt  
Increment: 0.1 Volt

Select the desired maximum voltage (span value) of reheat ramp. The maximum value (Step 23) is restricted by the minimum value (Step 22). In other words, the maximum value must be greater than the minimum value.



### Control Ramps

#### 24. "CONTROL RAMP REHEAT"



Default: 2.0°C [4°F]  
 Range: 0.5°C to 5.0°C [1°F to 10°F]  
 Increment: 0.5°C [1°F]

Select the desired value for the reheat proportional band. The heating  symbol is also displayed.

#### 25. "CONTROL DEAD BAND REHEAT"



Default: 0.3°C [0.6°F]  
 Range: 0.3°C to 5.0°C [0.6°F to 10.0°F]  
 Increment: 0.1°C [0.2°F]

Select the desired value for the reheat dead band. The heating  symbol is also displayed.

#### 26. "CONTROL RAMP HEATING"



Default: 2.0°C [4°F]  
 Range: 0.5°C to 5.0°C [1°F to 10°F]  
 Increment: 0.5°C [1°F]

Select the desired value for the heating proportional band. The heating  symbol is also displayed.

#### 27. "CONTROL RAMP COOLING"



Default: 2.0°C [4°F]  
 Range: 0.5°C to 5.0°C [1°F to 10°F]  
 Increment: 0.5°C [1°F]

Select the desired value for the cooling proportional band. The cooling  symbol is also displayed.

#### 28. "CONTROL DEAD BAND HEATING"



Default: 0.3°C [0.6°F]  
 Range: 0.3°C to 5.0°C [0.6°F to 10.0°F]  
 Increment: 0.1°C [0.2°F]

Select the desired value for the heating dead band. The heating  symbol is also displayed.

#### 29. "CONTROL DEAD BAND COOLING"



Default: 0.3°C [0.6°F]  
 Range: 0.3°C to 5.0°C [0.6°F to 10.0°F]  
 Increment: 0.1°C [0.2°F]

Select the desired value for the cooling dead band. The cooling  symbol is also displayed.

### Other Settings

#### 30. "COOLING ANTI CYCLE MINUTES"



Default: 2 minutes  
 Range: 0 to 15 minutes  
 Increment: 1 minute

To protect the compressor, set the delay in minutes before activating or reactivating the cooling contact. The cooling  symbol is also displayed.

#### 31. "ADJUST INTGRAL TIME IN SECONDS"



Default: 0 second  
 Range: 0 to 250 seconds  
 Increment: 5 seconds

Select the desired value for the integration factor compensation.

#### 32. "ADJUST DAMPING FACTOR SECONDS"



Default: 0 second  
 Range: 0 to 10 seconds  
 Increment: 1 second

Select the desired value for the damping factor. The fan  symbol and the cooling  symbol are also displayed.

### Fan Settings

#### 33. "SELECT FAN SPEED SIGNAL"



Default: 3 (speed fan contact)  
 Range: 1 (speed fan contact), 2 (speed fan contact), 3 (speed fan contact), AnLG (Analog)

Select the desired fan speed. If you have selected the speed fan contact option, select the speed, and go to Step 36. The fan  symbol is also displayed.

#### 34. "MIN VDC ANALOG OUTPUT FAN"



Default: 0.0 Volt  
 Range: 0.0 to 10.0 Volt  
 Increment: 0.1 Volt

Select the desired minimum voltage (zero value) for fan ramp. The minimum value (Step 34) is restricted by the maximum value (Step 35). In other words, the minimum value should be less than the maximum value. The fan  symbol is also displayed.

#### 35. "MAX VDC ANALOG OUTPUT FAN"



Default: 10.0 Volt  
 Range: 0.0 to 10.0 Volt  
 Increment: 0.1 Volt

Select the desired maximum voltage (span value) for fan ramp. The maximum value (Step 35) is restricted by the minimum value (Step 34). In other words, the maximum value must be more than the minimum value. The fan  symbol is also displayed.

#### 36. "ENABLE FAN AUTO MODE"



Default: Yes (Enable)  
 Range: Yes (Enable)/No (Disable)

Select the Enable or Disable option to allow the user to adjust the Automatic mode. The fan  symbol is also displayed.

**If you selected No (disable), go to Step 38.**

#### 37. "FAN AUTO TIMEOUT MINUTES"



Default: 2 minutes  
 Range: 0 to 15 minutes  
 Increment: 1 minute

Select the desired value for the automatic shutoff delay. The fan  symbol is also displayed.

### External Temperature Sensor

#### 38. "EXTERN SENSOR TEMPER"



Default: OFF (input none rewired)  
 Range: OFF (input none rewired), t10.0 (external temperature sensor 10.0 KΩ)

Select the sensor that should be rewired to the analog output.

- If you select OFF, the thermostat will be controlled by its internal temperature sensor.
- If you select t10.0, the thermostat will be controlled by an external temperature sensor.

**If you selected the OFF option, go to Step 40.**

#### 39. "EXTERN TEMPER SENSOR OFFSET"



Offset: Max. ± 5°C  
 Range: 0.0°C to 50.0°C [41.0°F to 122.0°F]  
 Increment: 0.1°C [0.2°F]

This option appears if you have set one of the analog inputs to **t10.0** (External temperature sensor 10.0 KΩ) at step 38. When the thermostat is connected to the appropriate analog input (AI1 or AI2), the display shows the temperature read by the external temperature sensor. Adjust the offset by comparing it with a known value (e.g. thermometer). If the sensor is not connected or short circuited, the display is blank "Error", and the error symbol  is displayed.

### No Occupancy

#### 40. "SELECT OCC CONTACT"

-  Default: NO (Normally Open)  
Range: NO (Normally Open)/NC (Normally Close)

Select the desired occupancy contact option. The moon ☾ symbol is also displayed.

#### 41. "NO OCC DELAY OVERRIDE MINUTES"

-  Default: 120 minutes  
Range: 0 to 180 minutes  
Increment: 15 minutes

Select the desired derogation time. If you do not wish to select any time, set it to 0. The moon ☾ symbol is also displayed.

#### 42. "NO OCC HEATING SETPNT"

-  Default: 16.0°C [61°F]  
Range: 10.0°C to 40.0°C [50°F to 104°F]  
Increment: 0.5°C [1°F]

Select the desired heating setpoint temperature during the no occupancy period. The maximum value is restricted by the cooling setpoint in the no occupancy period (Step 43). In other words, the maximum value must be greater than the no occupancy cooling setpoint value. The moon ☾ and heating ⬆ symbols are also displayed.

#### 43. "NO OCC COOLING SETPNT"

-  Default: 28.0°C [82°F]  
Range: 10.0°C to 40.0°C [50°F to 104°F]  
Increment: 0.5°C [1°F]

Select the desired cooling setpoint temperature during the no occupancy period. The minimum value is restricted by the heating setpoint in the no occupancy period (Step 42). In other words, the minimum value must be less than the no occupancy heating setpoint value. The moon ☾ and cooling \* symbols are also displayed.

### Anti-Freeze

#### 44. "ENABLE ANTI FREEZE PROTECT"

-  Default: No (Disable)  
Range: No(Disable)/Yes (Enable)

If this option is enabled, heating starts automatically when the temperature drops to 4°C [39°F], even if the thermostat is in OFF mode. Once the temperature reaches 5°C [41°F], the heating stops.

### BACnet Settings

#### 45. "AUTO BAUDS RATE"

-  Default: Yes (Enable)  
Range: Yes (Enable)/No (Disable)

Enable or disable Auto Baud Rate Detection. If you enable this option, the controller configures its baud rate automatically by detecting the network speed upon connection to the network (**go to Step 46**). If you disable this option, you must select the baud rate manually (**go to Step 47**).

#### 46. "AUTO COMPORT BAUDS RATE"

-  Default: No default (information display only)  
Range: 9600, 19200, 38400, 76800

If you enabled Auto Baud Rate Detection at Step 45, the display shows the baud rate that has been detected. **Go to Step 48**.

#### 47. "ADJUST COMPORT BAUDS RATE"

-  Default: 9.6 kBps  
Range: 9.6k, 192.k, 38.4k, 76.8k

If you disabled Auto Baud Rate Detection at Step 45, select the required baud rate manually.

#### 48. "ADJUST MSTP MAC ADDRESS"

-  Default: 1  
Range: 0 to 254  
Increment: 1

Select the desired MS/TP MAC Address. Each device on the network must have a unique MAC address.

### 49. "COPY CONFIG"



Default: No  
Range: Yes/No

Select Yes to copy the configuration of the existing device to other devices of the same type on the network. **If you select No, go to Step 53.**

### 50. "SELECT BEGIN ADDRESS"



Default: 0  
Range: 0-254  
Increment: 1

Select the first address you want to copy to. For example, if you select MAC address 1 as the begin address and 54 as the end address, all the devices from 1 to 54 will receive the configuration of the current device.

### 51. "SELECT END ADDRESS"



Default: "begin address"  
Range: "begin address + 63"  
Increment: 1

Select the last address you want to copy to. You cannot copy more than 64 addresses at once.

### 52. "COPY CONFIG RESULT"



Range: "Copy Config" followed by one of these results:  
"Succeed", "Proger", "Typeerr", "Modlerr", "Memerr", "Slave", "Commerr"

Displays "Succeed" if the addresses have been copied successfully. Otherwise, an error message appears with the associated MAC address. You can scroll through the addresses and see the error message associated with each address. The following is a complete list of error messages:

#### "COPY CONFIG SUCCEED"

Copy config was successful.

#### "COPY CONFIG PROGERR"

Copy config failed because the target device is in Program Mode.

#### "COPY CONFIG TYPEERR"

Copy config failed because the target device is not the same as the source device. For example, copying a TRO configuration to a TFC device.

#### "COPY CONFIG MODLERR"

Copy config failed because the model number of the source device and the target device is not the same. For example, copying a TFCB24F3XYZ1 configuration to a TFC24F3YZ1.

#### "COPY CONFIG MEM ERR"

Copy config failed because the software/application version of the source device and the target device is not the same.

#### "COPY CONFIG SLAVE"

The target device has a slave address and it cannot respond to the master. Manually verify that the configuration was copied correctly or avoid using a slave address (128 - 254).

#### "COPY CONFIG COMMERR"

Copy config failed because the target device did not respond after 3 attempts. Either the address does not exist or there is a problem with the wiring or with noise.

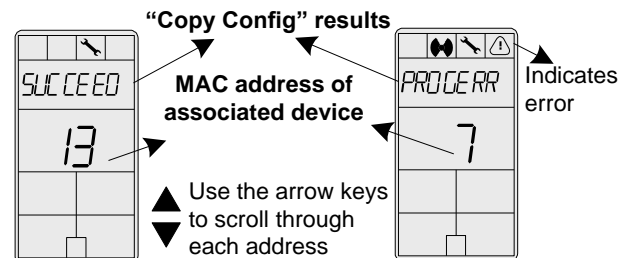

### 53. "ADJUST DEVICE INSTANC 0153000"





Default: No  
Range: No/Yes

To change the device instance, select Yes and continue to the next step. If you select No, the device instance will be modified automatically according to the MAC address (the menu starts over at Step 1).

### 54. "0153000"













Default: "current value"  
 Range: 0 to 4194302  
 Increment: 1

Use the arrow buttons to change the value and press  to move to the next digit on the right or press  to move to the digit on the left. Ensure that you provide a unique device instance. Set the Jumper (JP3) to "RUN" mode (Operation Mode) to save the changes.

## BACnet Setup Operation Mode

The BACnet Setup mode is accessible through the normal Operation mode.

1. The Mode Selector Jumper (JP3) must be set to the "RUN" mode (Operation Mode). Refer to Wiring on page 2.
2. Press the  and  buttons for 5 seconds. The "ENTER PASSWORD" screen appears.
3. Enter the password (637) within 1 minute. Use the arrow buttons  and  to increase or decrease the value and the ,  to advance and return to the digits respectively. If you enter the wrong password, the thermostat displays "ERROR" and returns to Operation Mode.
4. If you enter the password correctly, you will be taken to the BACnet program mode. The  symbol is displayed indicating that the BACnet mode is active. In the BACnet mode, press the  button to advance to the next program function and the  to return to the previous program function. Use the  and  buttons to adjust the values.

The thermostat will return to normal mode if you navigate through the entire menu and do not make any selection, or if you do not press any button for 5 minutes. The changed values will be saved automatically.

### 1. "AUTO BAUDS RATE" TO "ADJUST DEVICE INSTANCE"



Range: Steps 45 to 54  
 Page: Page 11 and 13

These BACnet setup steps are exactly the same as those in the Programming Mode. Please refer to Steps 45 to 54 starting on page 11. When complete continue to the following step.

### 2. "INSIDE TEMPER SENSOR OFFSET"



Offset: Max.  $\pm 5^{\circ}\text{C}$   
 Range:  $10.0^{\circ}\text{C}$  to  $40.0^{\circ}\text{C}$  [ $50.0^{\circ}\text{F}$  to  $104.0^{\circ}\text{F}$ ]  
 Increment:  $0.1^{\circ}\text{C}$  [ $0.2^{\circ}\text{F}$ ]

Compare the displayed temperature reading with a known value from a thermometer. To offset or calibrate the sensor, use the arrows button to set the desired temperature reading. This is useful for thermostats installed in areas where the temperature read is slightly different than the room's actual temperature. For example, a thermostat placed right under the air diffuser.

### 3. "EXTERN TEMPER SENSOR OFFSET"



Offset: Max.  $\pm 5^{\circ}\text{C}$   
 Range:  $0.0^{\circ}\text{C}$  to  $50.0^{\circ}\text{C}$  [ $41.0^{\circ}\text{F}$  to  $122.0^{\circ}\text{F}$ ]  
 Increment:  $0.1^{\circ}\text{C}$  [ $0.2^{\circ}\text{F}$ ]

This option appears if you have set one of the analog inputs to **t10.0** (External temperature sensor 10.0 k $\Omega$ ) at step 38. When the thermostat is connected to input (AI1), the display shows the temperature read by the external temperature sensor. Adjust the offset by comparing it with a known value (e.g. thermometer). If the sensor is not connected or short circuited, the display is blank "Error", and the error symbol  is displayed.

### Operation Mode



The Mode Selector Jumper (JP3) must be set to the "RUN" mode (Operation Mode). Refer to Wiring on page 2. To exit, set the Jumper (JP3) back to the "PGM" mode (Programming Mode). All changes will be saved.

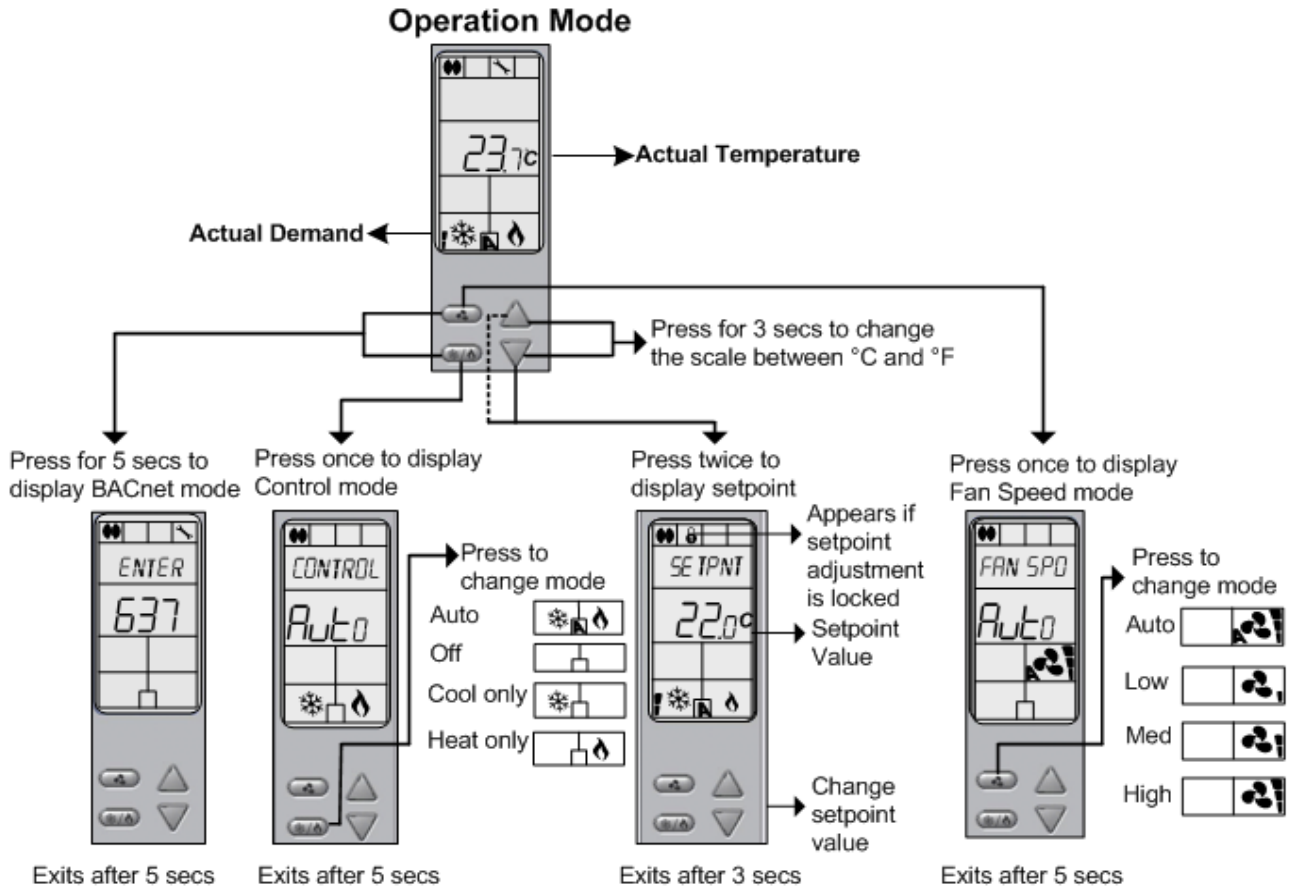



### Power Up

Upon power up, the LCD illuminates and all segments appear for 2 seconds. The thermostat then displays its current version for 2 seconds.





### LCD Backlight

Pressing any button on the thermostat illuminates the LCD for 4 seconds.

### Temperature

The thermostat always displays the temperature reading. If the sensor is disconnected or short circuited then "OFF", "- -",  (alarm symbol) are displayed. To toggle the temperature scale between °C and °F, press both the  and  buttons for 3 seconds.

### Setpoint

To display the setpoint, press the  or  button twice. The setpoint appears for 3 seconds. To adjust the setpoint, press the  and  buttons while the temperature is displayed. If the setpoint adjustment has been locked (Step 4 on page 6), the lock  symbol appears.

### No Occupancy Mode

This function is only available if you have selected the derogation time at Step 41 on page 11. If the no occupancy is triggered, the thermostat enters the No Occupancy Mode (the **▷** symbol appears) and uses the heating and cooling setpoints defined at Step 42 and 43 on page 11.

The user can press any button to override the duration of No Occupancy. The **▷** symbol flashes to indicate that the derogation period is on. If the **▷** symbol does not flash, it means that the derogation period is complete or that the No Occupancy Mode derogation option has been locked.

### Control Mode

To access the Control Mode, press the  button. The Control Mode appears for 5 seconds. These options can vary depending on the options selected at Steps 6 and 7 on page 6.

- Auto (Automatic Cooling or Heating)
- Cooling only (on)
- Heating only (on)
- OFF

### Fan Speed Selection Mode

To access the Fan Speed selection mode, press the  button. The mode appears for 5 seconds. These options can vary depending on the fan speed signal and auto mode settings at Step 33 and Step 36 on page 10.

- Automatic speed. This option is available if you have selected **Yes** (Enable) at Step 36 in Programming Mode.
- Low speed
- Medium speed
- High speed
- Off

