

### Models

<b>EFCB10TU2</b>	(24Vac / 2 relays)
<b>EFCB10TU4</b>	(24Vac / 4 relays)
<b>EFCB11TU2</b>	(120Vac / 2 relays)
<b>EFCB11TU4</b>	(120Vac / 4 relays)
<b>EFCB12TU2</b>	(240Vac / 2 relays)
<b>EFCB12TU4</b>	(240Vac / 4 relays)

### TFL24 Series Digital Room Sensor

<b>TFL24</b>	(With temperature sensor)
<b>TFLH24</b>	(With temperature and humidity sensor)
<b>TFLG24</b>	(With temperature and CO <sub>2</sub> sensor)
<b>TFLGH24</b>	(With temperature, CO <sub>2</sub> and humidity sensors)

### TDF Series Digital Room Sensor

<b>TDF00</b>	(Vertical Grey LCD, white enclosure)
<b>TDF30</b>	(Vertical Black LCD, black enclosure)
<b>TDF60</b>	(Vertical Black LCD, white enclosure)
<b>TDF10</b>	(Horizontal Grey LCD, white enclosure)
<b>TDF40</b>	(Horizontal Black LCD, black enclosure)
<b>TDF70</b>	(Horizontal Black LCD, white enclosure)

### Description

The EFCB Series Networkable Fan Coil Controller, and TFL24 and TDF Series Digital Room Sensors are designed for simple and accurate control of any fan coil application. The BACnet Fan Coil Controller is mounted inside the fan coil cabinet and incorporates a configurable fan coil algorithm, variable three speed fan control and either modulating or digital heating and cooling outputs. All inputs and high/low voltage outputs are centralized at the control module in the fan coil cabinet.

### Features

- Built-in configurable fan coil algorithms
- Up to 10 inputs and 15 outputs (configurable)
- Select direction on digital inputs and all outputs
- Selectable proportional control band and dead band
- Selectable fan speed contacts
- Independent cool/heat setpoint for NSB/OCC mode
- No occupancy and NSB override
- Selectable internal or external temperature sensor (10K $\Omega$ )
- Change over by contact or 10K $\Omega$  temperature sensor
- Internal and external temperature sensor calibration
- Freeze protection
- Multi level lockable access menu and setpoint
- Removable, raising clamp, non-strip terminals

#### Digital Room Sensor Features

- Backlit LCD with simple icon and text driven menus
- Select digital room sensor's default display
- BACnet service port via on-board mini USB connector
- Selectable Fahrenheit or Celsius scale
- 3-wire connection to controller and 4 push buttons



EFCB Series



TFL24 Series



TDF00 / TDF30 / TDF60 Series



TDF10 / TDF40 / TDF70 Series

### Applications

- Compatible with 2 or 4 pipe systems
- Fan coil unit (up to 3 speeds and/or analog 0-10 Vdc)
- Cooling signal (on/off, floating or modulating 0-10 Vdc)
- Heating signal (on/off, floating, pulse or modulating 0-10 Vdc)
- Cool, Heat, Reheat, Reheat with fan, Changeover, Fan, Humidify and Dehumidify by cooling.

### Network Communication

- BACnet<sup>®</sup> MS/TP or Modbus communication port
- Select MAC address via DIP switch or via network
- Automatic baud rate detection

#### BACnet MS/TP<sup>®</sup>

- Automatic device instance configuration
- Copy and broadcast configuration via digital room sensor menu or via BACnet to other controllers
- BACnet scheduler
- Firmware upgradeable via BACnet
- Support COV (change of value)

#### Modbus

- Modbus @ 9600, 19200, 38400 or 57600 bps
- RTU Slave, 8 bits (configurable parity and stop bits)
- Connects to any Modbus master



## Controller Specifications

Description	EFCB10TU2 EFCB10TU4	EFCB11TU2 EFCB11TU4	EFCB12TU2 EFCB12TU4
Inputs	2 fixed analog inputs (external temp. and changeover sensors); 10K $\Omega$ or contact 4 analog inputs (0-10 Vdc or 10 K $\Omega$ via DIP switches) 3 configurable digital inputs 1 night setback or occupancy sensor input		
Outputs	4 analog , 0-10 Vdc configurable outputs (changeover/cooling/heating, fan, humidity) 4 configurable TRIAC outputs (changeover/cooling/heating) 3 speed fan (Motor and/or compressor inductive ratings: ¼ Hp/10 LRA/2.5 FLA 240 Vac Maximum Resistive ratings: 7 Amp/1680 W at 240 Vac Maximum); configurable up to 3 speeds 2 or 4 configurable digital outputs (changeover/cooling/heating, humidity, 3A dry contact)		
Power supply	24 Vac	120 Vac	240 Vac
Power consumption	8 VA max. 24 Vac thermal fused.		
BACnet	BACnet <sup>®</sup> MS/TP @ 9600, 19200, 38400 or 76800 bps (BAS-C)		
Modbus	Modbus RTU slave @ 9600, 19200, 38400 or 57600. Selectable parity and stop bit configuration: No parity, 2 stop bit Even parity, 1 stop bit Odd parity, 1 stop bit		
Communication Connections	24 AWG twisted-shield cable (Belden 9841 or equivalent)		
Electrical Connections	0.8 mm <sup>2</sup> [18 AWG] minimum		
Operating temperature	0°C to 50°C [32°F to 122°F]		
Storage temperature	-30°C to 50°C [-22°F to 122°F]		
Relative Humidity	5 to 95% non condensing		
Enclosure protection	IP 30 (EN 60529)		
Weight	635 g. [1.4 lb]		
Dimensions: A = 6.30"   160mm B = 5.00"   126mm C = 2.25"   57mm			

## Digital Room Sensor Specifications

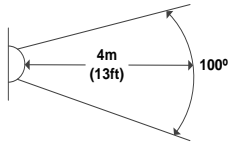
Description	TFL24 and TDF Series
<b>Temperature Sensor (TFL24)</b>	
<i>Setpoint Range</i>	10°C to 40°C [50°F to 104°F]
<i>Control Accuracy</i>	±0.5°C [0.9°F] @ 22°C [71.6°F] typical calibrated
<i>Display Resolution</i>	±0.1°C [0.2°F]
<b>Humidity Sensor (TFLH24, TFLGH24, and TDF models with Humidity Sensor)</b>	
<i>Setpoint Range</i>	10 to 65%RH
<i>Control Accuracy</i>	±3.5% RH
<i>Display Resolution</i>	0.1%
<b>CO<sub>2</sub> Sensor (TFLG24, TFLGH24, and TDF models with CO<sub>2</sub> Sensor)</b>	
<i>Operating Principle</i>	Self-calibrating, Non-Dispersive Infrared (NDIR)
<i>Sensor Range</i>	400 to 2000 ppm
<i>Accuracy</i>	±30 ppm ±3% of reading (Accuracy is defined after minimum 3 weeks of continuous operation)
<i>Response Time</i>	2 minutes by 90%
<b>PIR Motion Sensor (TDF00 / TDF30 / TDF60 models with PIR Sensor)</b>	
<i>Operating Principle</i>	Passive Infrared (PIR)
<i>Detection Angle</i>	100°
<i>Detection Distance</i>	4m [13ft]
<i>Detection Area</i>	
<b>VOC Sensor (TDF00 / TDF30 / TDF60 Series models with VOC Sensor)</b>	
<i>Operating Principle</i>	Self-calibrating, Non-Dispersive Infrared (NDIR)
<i>Sensor Range</i>	0-1000 ppb isobutylene equivalent tVOCs
<i>Response Time</i>	<5 seconds for tVOC
<i>Start up Time</i>	15 minutes
<b>Other</b>	
Electrical connection	3 wires to EFCB controller and 2 wires (optional) to BACnet network service port 0.8 mm <sup>2</sup> [18 AWG] minimum
BACnet service port	Mini USB connector
Power supply	24Vac or 24Vdc
Power consumption	1VA
Operating temperature	0°C to 50°C [32°F to 122°F]
Storage temperature	-30°C to 50°C [-22°F to 122°F]
Relative humidity	5 to 95 % non condensing
Enclosure protection	IP 30 (EN 60529)
Weight	120 g. [0.25 lb]
<b>Note:</b> The TFL24/TDF digital room sensor functions only with the EFCB controller. All the inputs/outputs are located on the EFCB except for the temperature, humidity and CO <sub>2</sub> sensors built-in the TFL24/TDF and PIR and VOC sensors built in the TDF00 / TDF30 / TDF60 models.	



Dimensions

<p><b>TFL24</b></p> <p>A = 2.85"   73mm          B = 4.85"   123mm          C = 1.00"   24mm          D = 2.36"   60mm          E = 3.27"   83mm</p>	
<p><b>TDF10 / TDF40 / TDF70 Series</b></p> <p>A = 5.24"   133mm          B = 2.87"   73mm          C = 3.74"   95mm          D = 1.22"   31mm          E = 0.75"   19mm          F = 2.00"   51mm          G = 2.18"   55mm</p>	
<p><b>TDF00 / TDF30 / TDF60 Series</b></p> <p>A = 4.88"   124mm          B = 3.25"   83mm          C = 1.75"   44mm          D = 0.96"   24mm          E = 2.07"   53mm          F = 2.36"   60mm          G = 3.28"   83mm          H = 0.78"   20mm (without CO<sub>2</sub>)          0.95"   24mm (with CO<sub>2</sub>)</p>	

**TDF Models**

Horizontal Model #	Temp	RH	CO <sub>2</sub>
TDF10-100 TDF40-100 TDF70-100	•		
TDF10-101 TDF40-101 TDF70-101	•	•	
TDF10-102 TDF40-102 TDF70-102	•	•	•
TDF10-103 TDF40-103 TDF70-103	•		•

**TDF10 Series**

**TDF40 Series**

**TDF70 Series**

Vertical Model #	Temp	RH	CO <sub>2</sub>	PIR	VOC
TDF00-100 TDF30-100 TDF60-100	•				
TDF00-101 TDF30-101 TDF60-101	•	•			
TDF00-102 TDF30-102 TDF60-102	•	•	•		
TDF00-103 TDF30-103 TDF60-103	•		•		
TDF00-104 TDF30-104 TDF60-104	•			•	
TDF00-105 TDF30-105 TDF60-105	•	•		•	
TDF00-106 TDF30-106 TDF60-106	•	•	•		•
TDF00-107 TDF30-107 TDF60-107	•	•	•	•	•
TDF00-108 TDF30-108 TDF60-108	•	•	•	•	



**TDF00 Series**







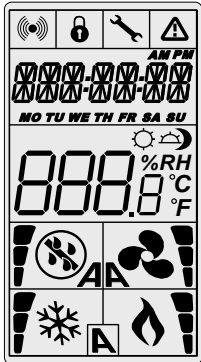





**TDF30 Series**

**TDF60 Series**

## Interface









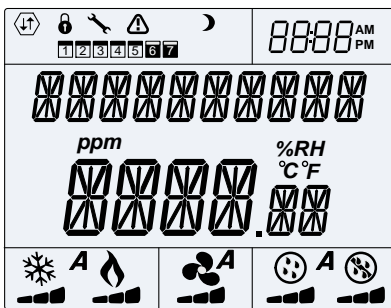





### TFL24



	Cooling ON A: Automatic		Communication Status		Alarm status
	Heating ON A: Automatic		Menu set-up Lock		Energy saving mode
	Fan ON A: Automatic		Programming mode (Technician setting)		Percentage of humidity
	Humidity ON 33, 66 or 100% output		Dehumidification ON 33, 66 or 100% output		°C: Celsius scale °F: Fahrenheit scale









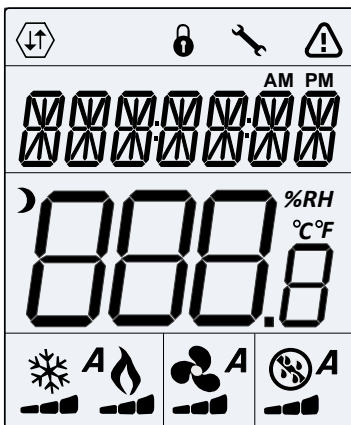



### TDF10 / TDF40 / TDF70 Series



	Network Communication		User Lock		Programming Mode (Technician Setting)
	Alarm Status		Energy Saving Mode (NSB/OCC)		Schedule
	Time		Parts Per Million		°C: Celsius Scale °F: Fahrenheit Scale %RH: Humidity
	Automatic Mode		Cooling		Heating
	Fan		Humidify		De-humidify

### TDF00 / TDF30 / TDF60 Series



	Network Communication		User Lock		Programming Mode (Technician Setting)
	Alarm Status		Energy Saving Mode (NSB/OCC)		Time
	°C: Celsius Scale °F: Fahrenheit Scale %RH: Humidity		Automatic Mode		Cooling
	Heating		Fan		Humidify/ De-humidify



## Mounting Instructions

### TFL24

**⚠ CAUTION: Remove power to avoid a risk of malfunction.**

- Remove the captive screw that's holding the base and the front cover of the unit together.
- Lift the front cover of the unit to separate it from the base.
- Pull all wires through the holes in the base.
- Secure the base to the wall using wall anchors and screws (supplied). Make the appropriate connections.
- Mount the control module on the base and secure using the screw.

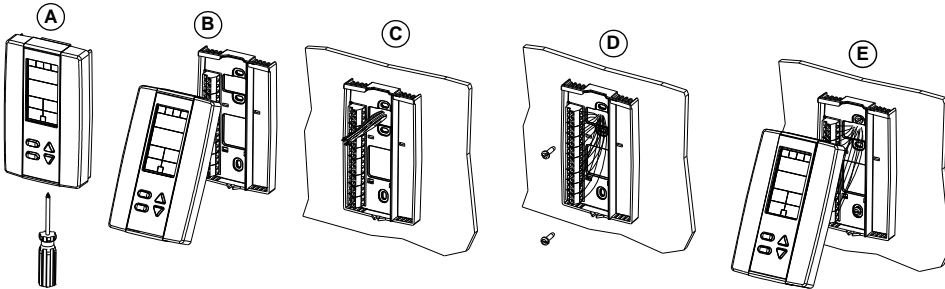

### TDF10 / TDF40 / TDF70 Series

**⚠ CAUTION: Remove power to avoid a risk of malfunction.**

- Remove the wall mounting plate (highlighted) from the back of the digital room sensor.
- Install the mounting plate on the gang box.
- Pull the wires through the base hole and make the appropriate connections.
- Mount the digital room sensor onto the wall plate. To mount it correctly, place the top of the digital room sensor on the mounting plate first and push it into the grooves to snap it into place.
- Secure the digital room sensor using the screw (supplied).

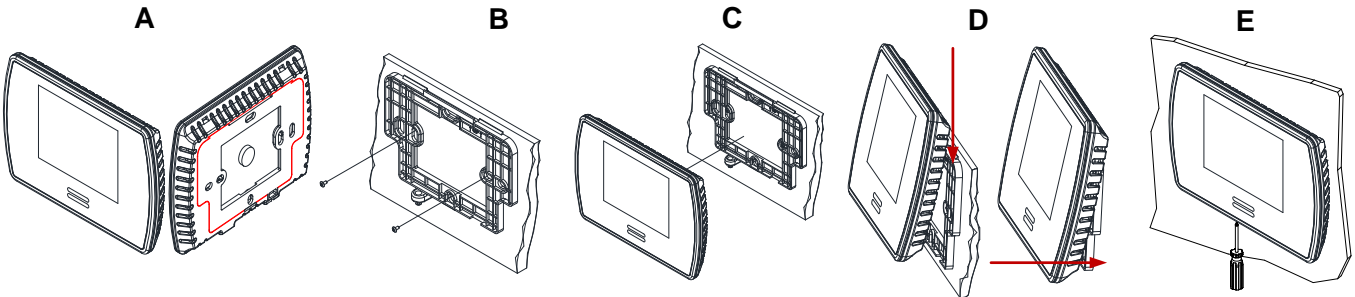

### TDF00 / TDF30 / TDF60 Series

**⚠ CAUTION: Remove power to avoid a risk of malfunction.**

- Remove the captive screw that's holding the base and the front cover of the unit together.
- Lift the front cover of the unit to separate it from the base.
- Pull all wires through the holes in the base.
- Secure the base to the wall using wall anchors and screws (supplied). Make the appropriate connections.
- Mount the control module on the base and secure using the screw.

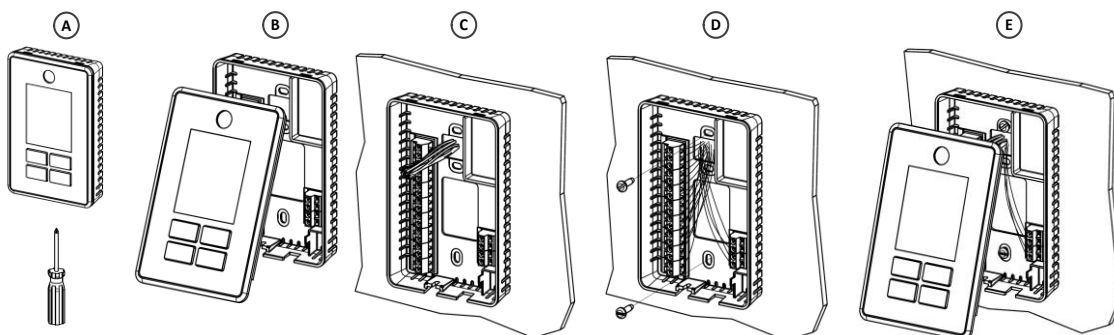





## BACnet or Modbus Address DIP Switch (DS2)

MAC address for communication, are selectable by DIP switch using binary logic. If you do not change device instance in program mode, it will be automatically modified according to the MAC address.



*Note: Avoid using addresses above 246 when selecting Modbus MAC address.*

MAC Address	DS.1 = 1	DS.2 = 2	DS.3 = 4	DS.4 = 8	DS.5 = 16	DS.6 = 32	DS.7 = 64	DS.8 = 128	Default Device Instance
0	OFF	OFF	OFF	OFF	OFF	OFF	OFF	OFF	153000
1	ON	OFF	OFF	OFF	OFF	OFF	OFF	OFF	153001
2	OFF	ON	OFF	OFF	OFF	OFF	OFF	OFF	153002
3	ON	ON	OFF	OFF	OFF	OFF	OFF	OFF	153003
4	OFF	OFF	ON	OFF	OFF	OFF	OFF	OFF	153004
...	...	...	...	...	...	...	...	...	...
126	OFF	ON	ON	ON	ON	ON	ON	OFF	153126
127	ON	ON	ON	ON	ON	ON	ON	OFF	153127

\* Slave addresses available by setting DS.8 to ON





### Wiring

We strongly recommend that all Neptronic products be wired to a separate grounded transformer and that transformer shall service only Neptronic products. This precaution will prevent interference with, and/or possible damage to incompatible equipment.

For 120/240Vac models, it is recommended to have separate power sources for the EFCB controller and the Fan Coil Unit, in order to protect the device circuitry from any surge in power supply.

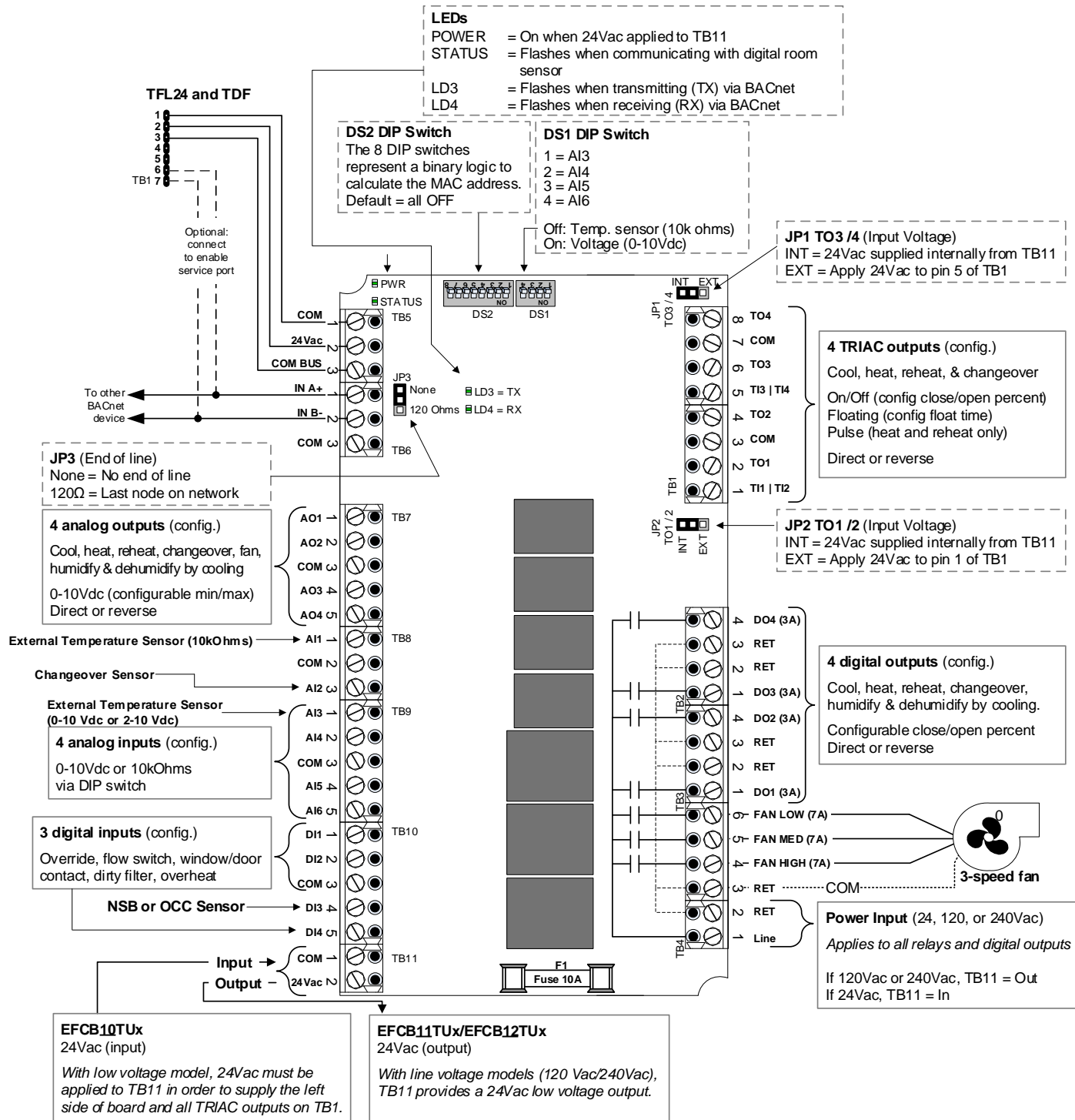

### PCB Drawings



#### TFL24 Digital Room Sensor

3 wire cable (TB1 #1, 2 & 3)

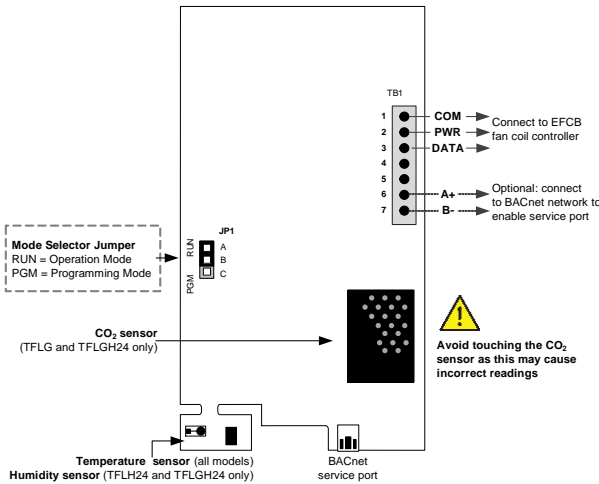
Connect TB1 #6 (A+) & #7 (B-) to EFCB to enable the BACnet service port.



#### Mode Selection (JP1)

	<p><b>RUN:</b> Digital Room Sensor is in <b>Operation Mode</b>. Digital Room Sensor must be set in this mode for normal system operation. If not locked, setpoint and control mode can be changed by the end user.</p>
	<p><b>PGM:</b> Digital Room Sensor is set in <b>Programming Mode</b>. Refer to the following sections for more details.</p>



#### TDF10 / TDF40 / TDF70 Series

3 wire cable (TB1 #1, 2 & 3)

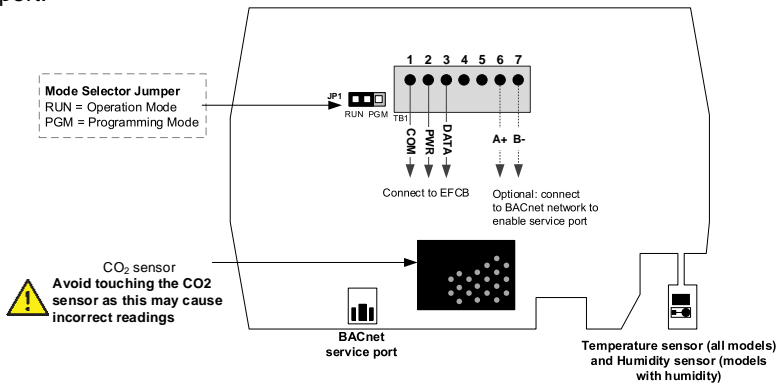
Connect TB1 #6 (A+) & #7 (B-) to EFCB to enable the BACnet service port.



#### Mode Selection (JP1)

	<p><b>RUN:</b> Digital Room Sensor is in <b>Operation Mode</b>. Digital Room Sensor must be set in this mode for normal system operation. If not locked, setpoint and control mode can be changed by the end user.</p>
	<p><b>PGM:</b> Digital Room Sensor is set in <b>Programming Mode</b>. Refer to the following sections for more details.</p>



#### TDF00 / TDF30 / TDF60 Series

3 wire cable (TB1 #1, 2 & 3)

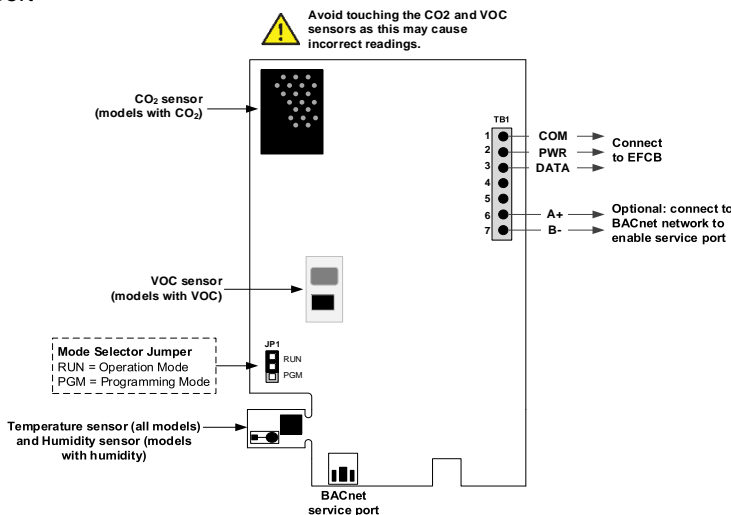
Connect TB1 #6 (A+) & #7 (B-) to EFCB to enable the BACnet service port









#### Mode Selection (JP1)

	<p><b>RUN:</b> Digital Room Sensor is in <b>Operation Mode</b>. Digital Room Sensor must be set in this mode for normal system operation. If not locked, setpoint and control mode can be changed by the end user.</p>
	<p><b>PGM:</b> Digital Room Sensor is set in <b>Programming Mode</b>. Refer to the following sections for more details.</p>

## Access to Menus

The menu overviews and options are the same for both TFL24 and TDF digital room sensors. However, the action button or the button used to access the menus and save changes is different in the digital room sensors. Use the following menu overviews with the appropriate action button as per your digital room sensor.

### Action Buttons on Digital Room Sensor

TFL24	Action Button		Task
	TDF	TDU*	
			Press to access the programming menus and save any changes.
			Press to return to the previous step without saving.

**\* If the EFCB controller is being configured using a TDU digital room sensor, use the corresponding buttons shown in the table above to navigate through the menu.**



*Note: Prior to going into Programming Mode, remove the connection cable between the EFCB and the TFL/TDF/TDU and set the Mode Selection jumper (JP1) to PGM on the digital room sensor. Reestablish the connection in order to access the programming menus and to make any changes. Once all menu changes have been made, remove the connection cable again before setting jumper JP1 back to RUN, and then reconnect the cable to resume normal operation.*

### Analog Inputs – Menu Overview (1 of 8) | AI2 to AI6

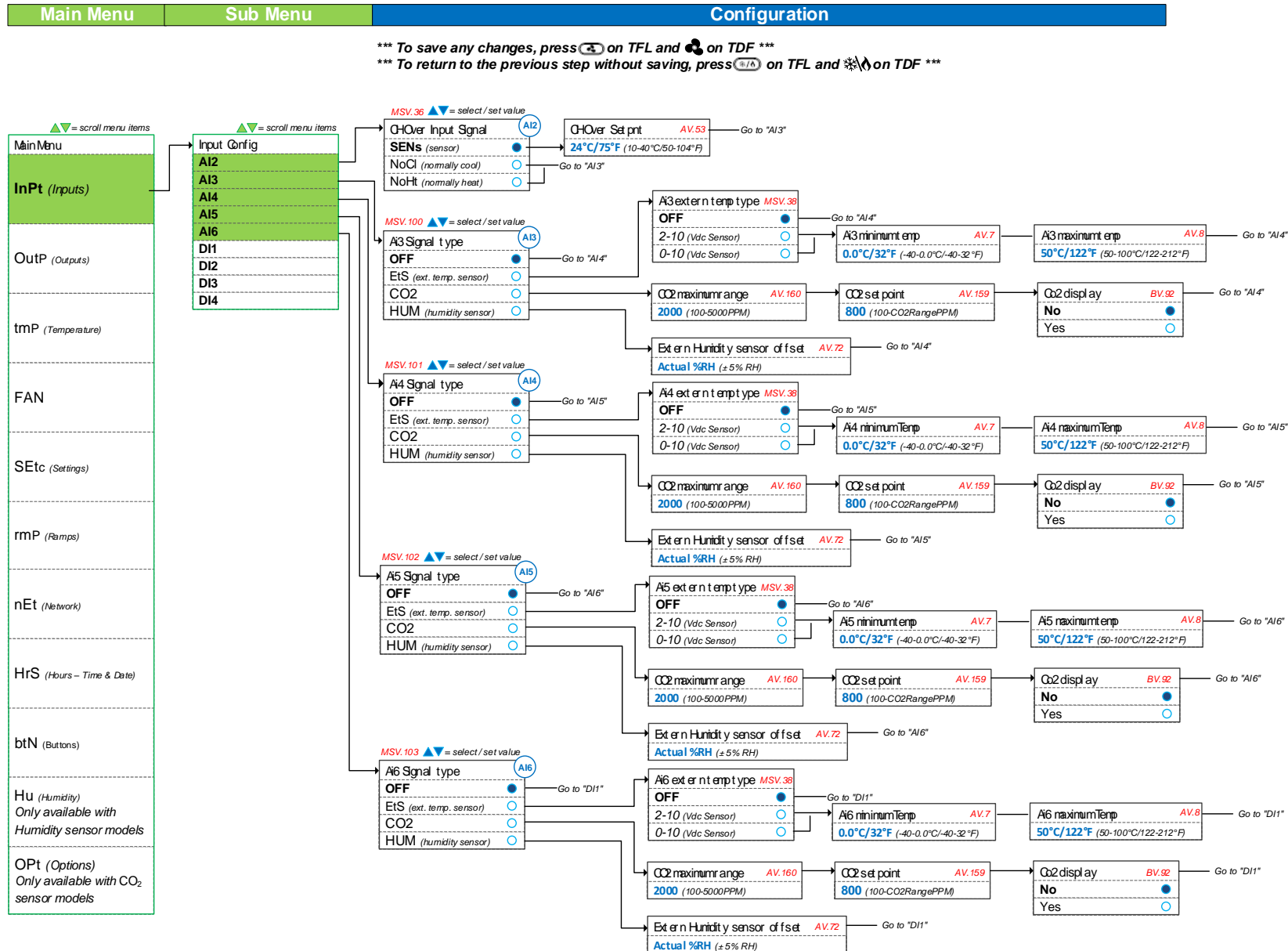

### Digital Inputs – Menu Overview (2 of 8) | DI1 to DI4

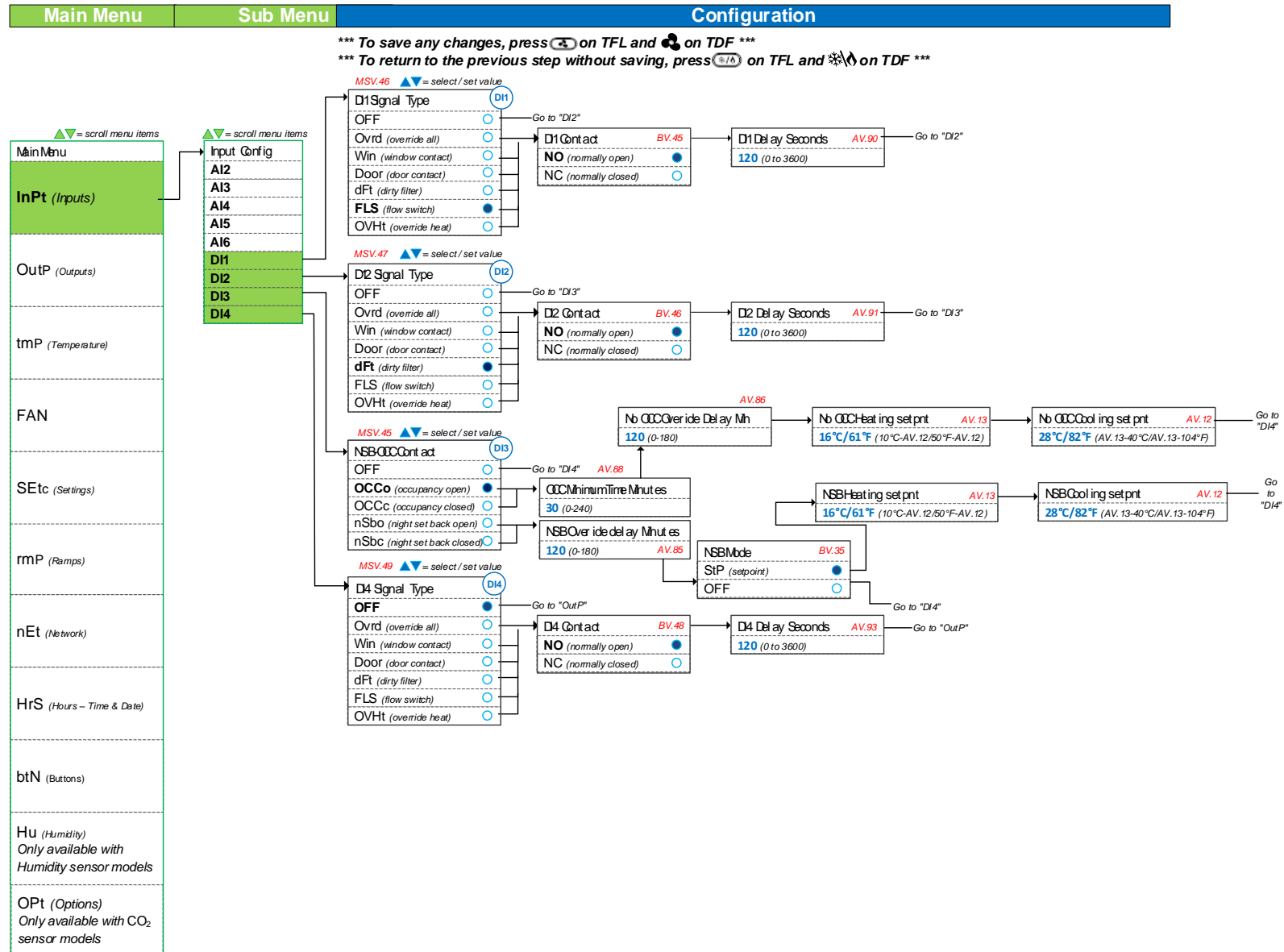

### TRIAC Outputs – Menu Overview (3 of 8) | TO1 to TO4

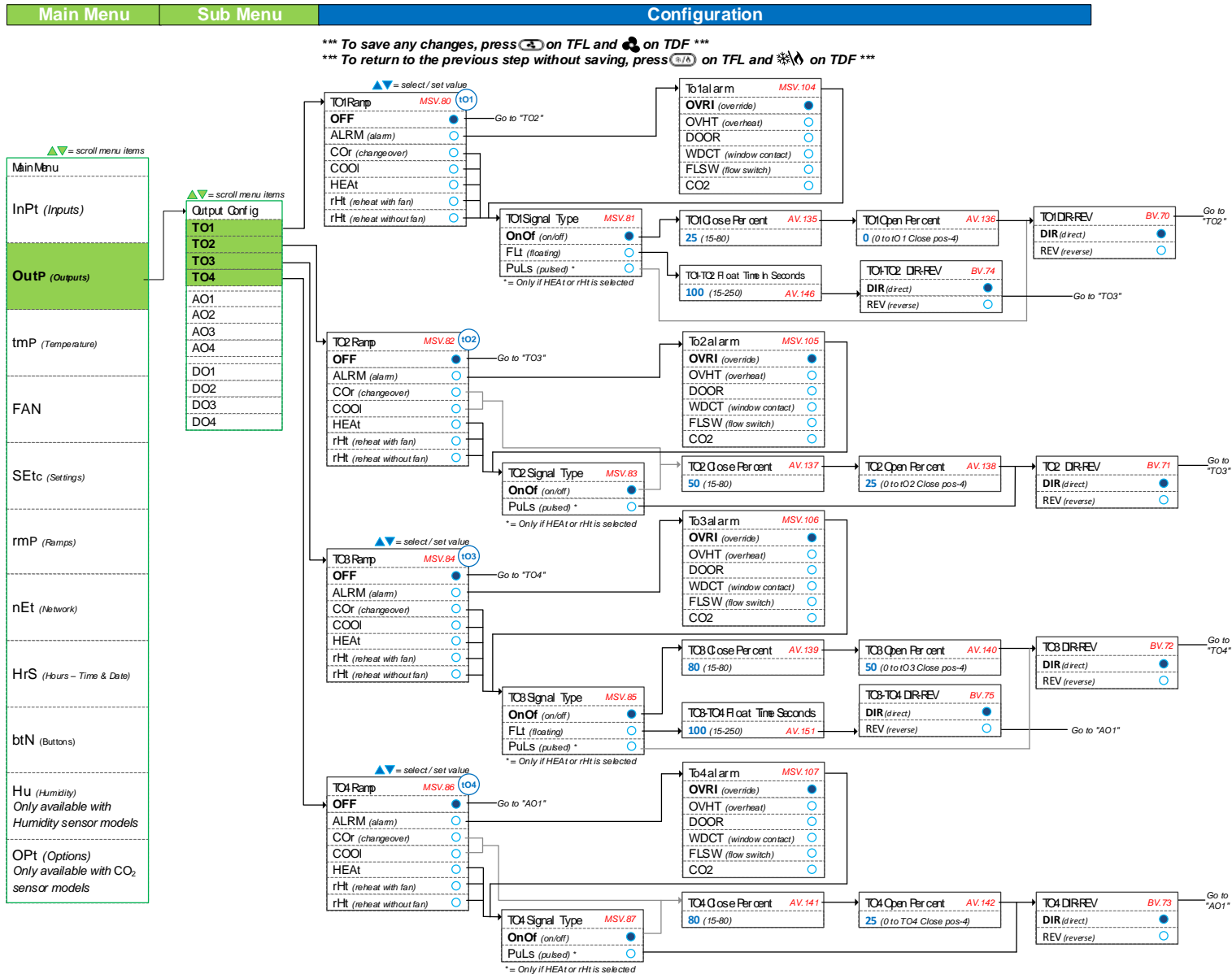

### Analog Outputs – Menu Overview (4 of 8) | AO1 to AO4

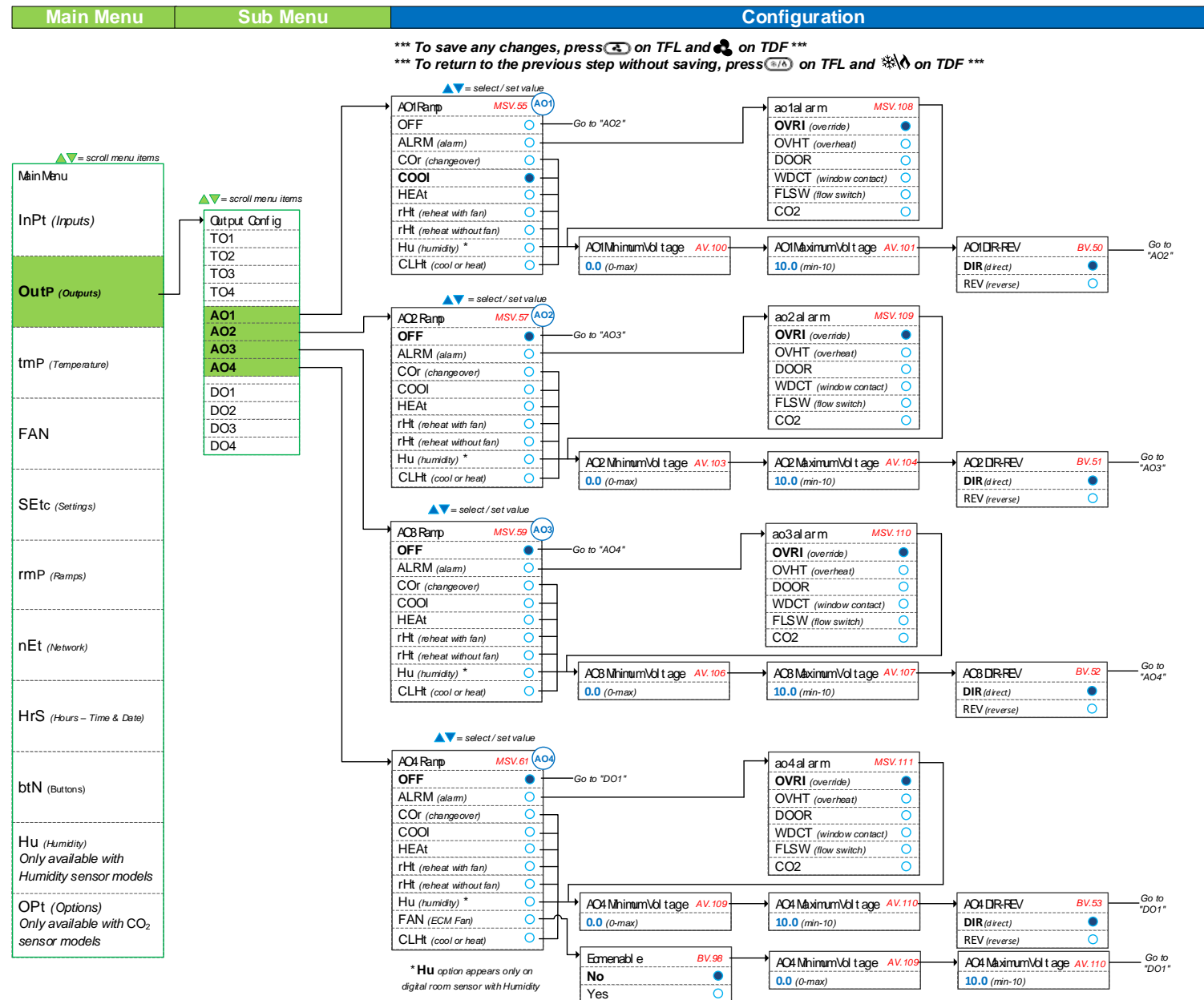



### Digital Outputs – Menu Overview (5 of 8) | DO1 to DO4

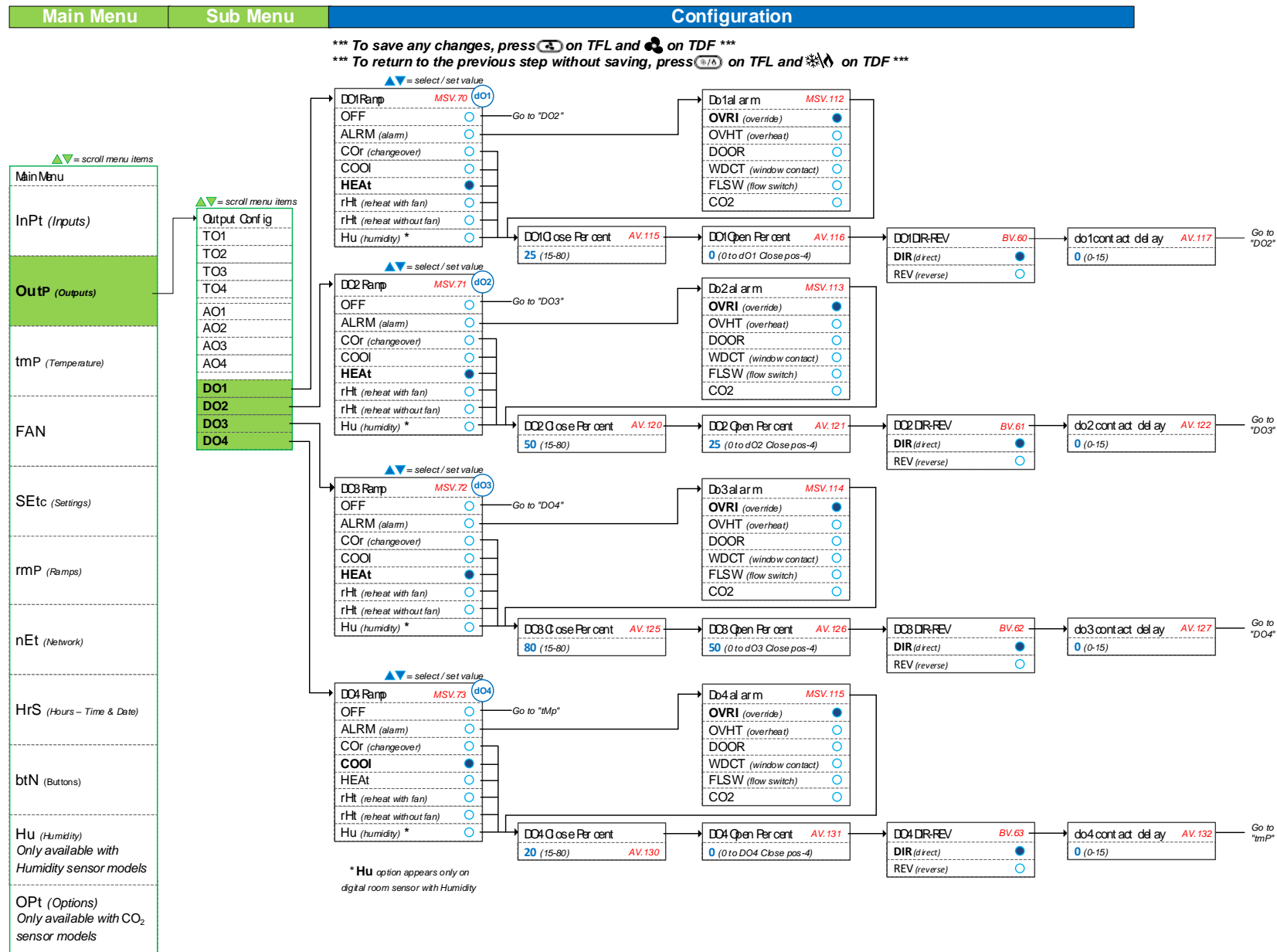

### Settings – Menu Overview (6 of 8) | Temp, Fan, Settings and Ramps

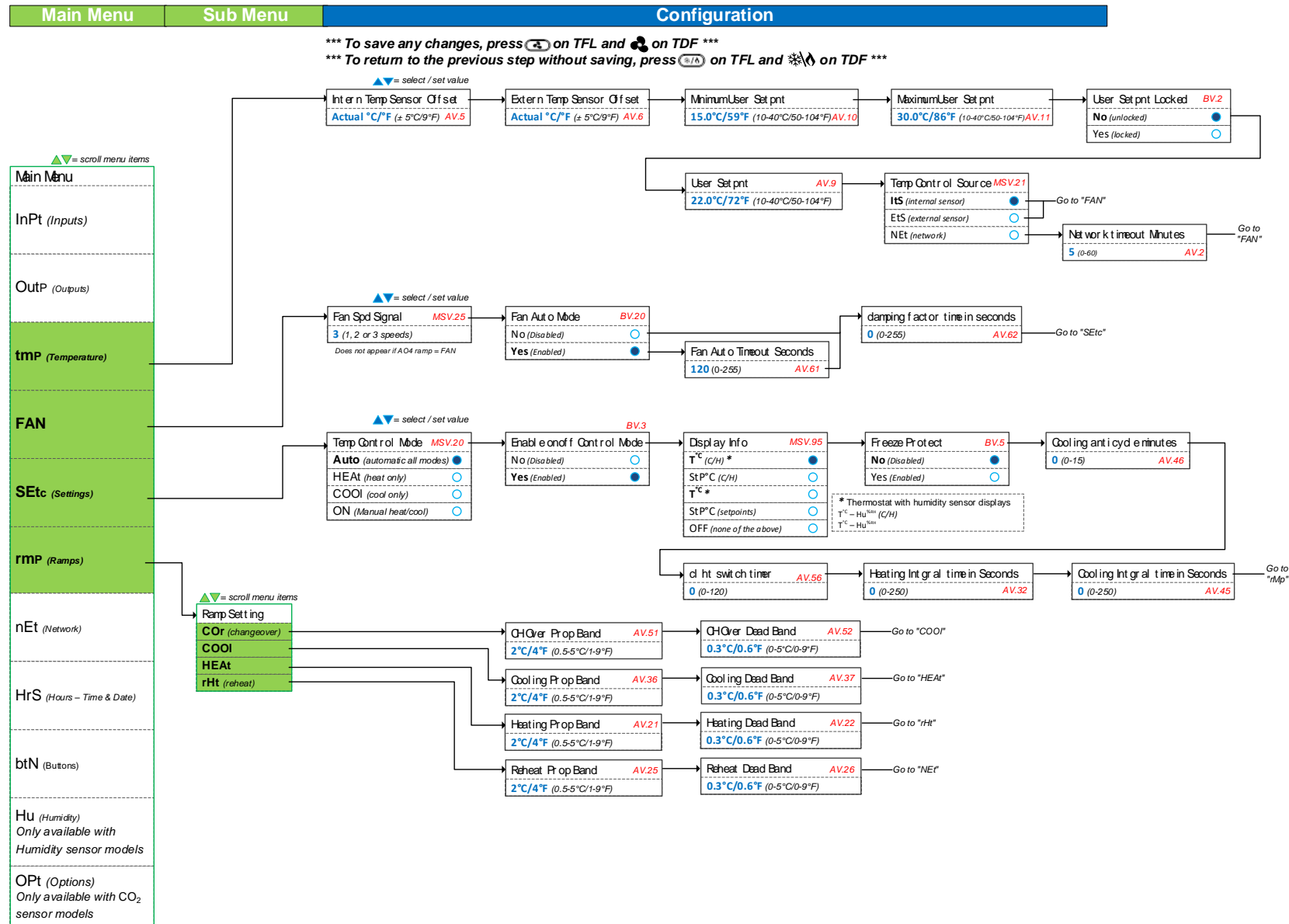

### Network and Calendar – Menu Overview (7 of 8) | Network, Time, Buttons and Options

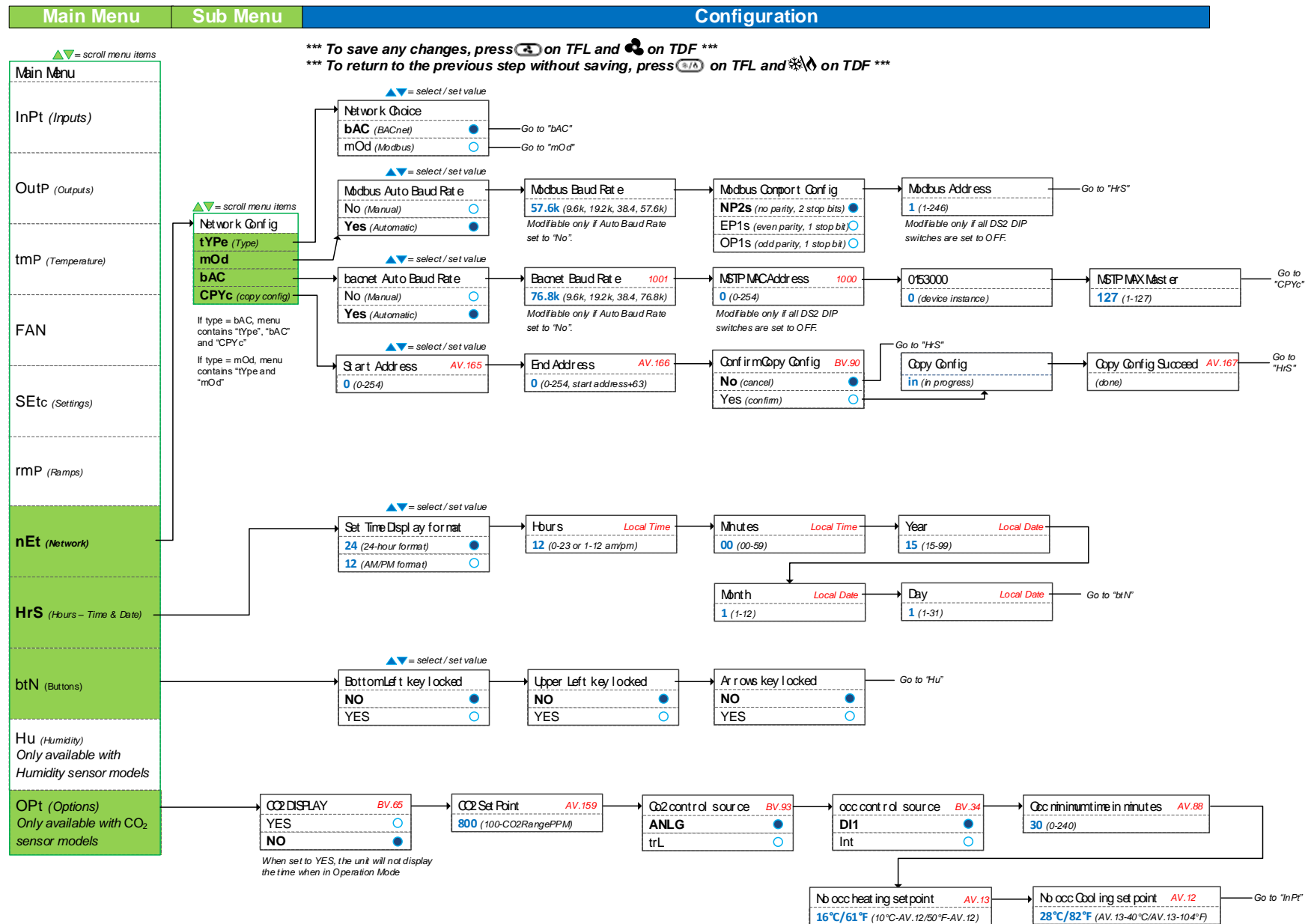

### Humidity – Menu Overview (8 of 8) | Humidity

Only available when a digital room sensor with humidity is connected to the controller

Main Menu	Sub Menu	Configuration
-----------	----------	---------------

\*\*\* To save any changes, press **↵** on TFL and **⏏** on TDF \*\*\*  
 \*\*\* To return to the previous step without saving, press **⏏** on TFL and **⏏** on TDF \*\*\*  
 \*\*\* The Hu (Humidity) menu is available only on digital room sensor with humidity \*\*\*

▲▼ = scroll menu items

Main Menu
InPt (Inputs)
OutP (Outputs)
tmP (Temperature)
FAN
SEtc (Settings)
rmp (Ramps)
nEt (Network)
HrS (Hours – Time & Date)
btN (Buttons)
<b>Hu (Humidity)</b> Only available with Humidity sensor models
OPt (Options) Only available with CO <sub>2</sub> sensor models

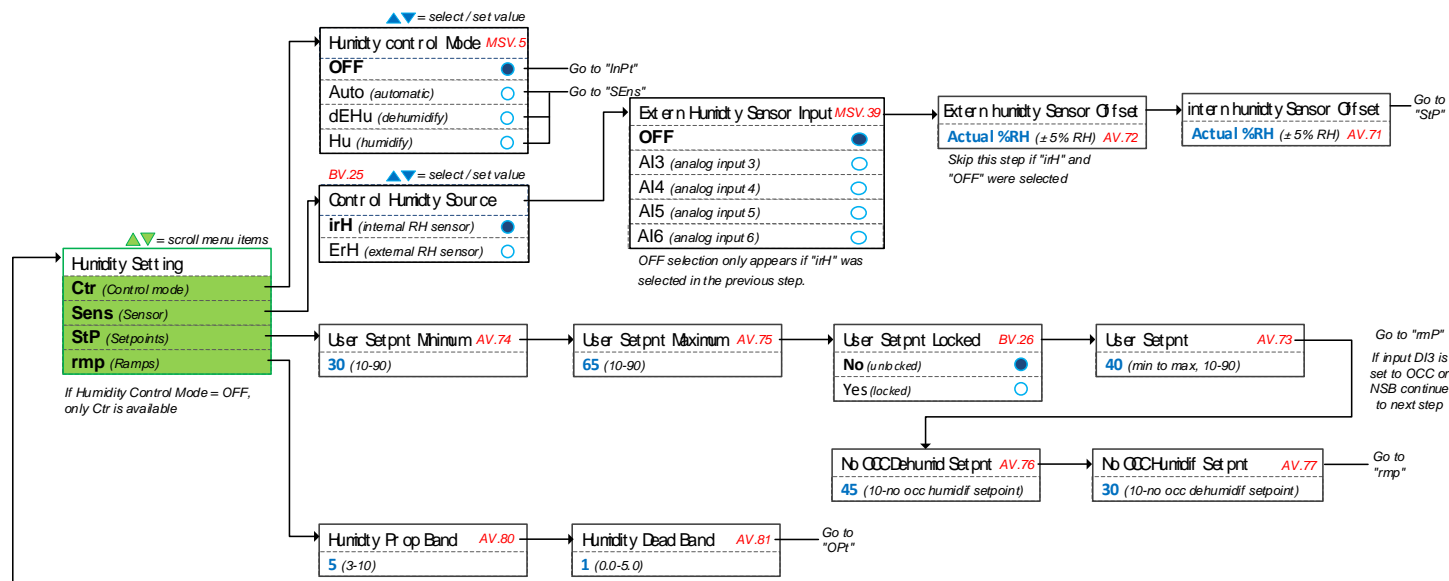



## Operation Menus

This menu is accessible through normal operation mode.

**Note:** Since the action buttons are different on the TFL24 and TDF digital room sensor series, both buttons have been included in the instructions. Refer to the Action Buttons on Digital Room Sensor section to know and use the button as available on your digital room sensor.

- The Mode Selector jumper (JP1) of the digital room sensor must be set to the "RUN" position (Operation Mode). Refer to Wiring on page 9.
- Press the [ / ] and [ / ] buttons simultaneously for 5 seconds. The "Enter Password" screen appears.
- Enter the password within 1 minute by using the arrow keys to increase or decrease the value and the [ / ] and [ / ] buttons to toggle between the digits.
  - Password **372** = Sensor Offset Menu
  - Password **637** = Network Settings Menu
- If you enter the wrong password, the digital room sensor displays "Error" and returns to Operation Mode. The digital room sensor will return to normal mode if you navigate through the entire menu and do not make any selection, or if you do not press any key for 5 minutes. The changed values will be saved automatically.

### Menu 372 – Sensor Offset

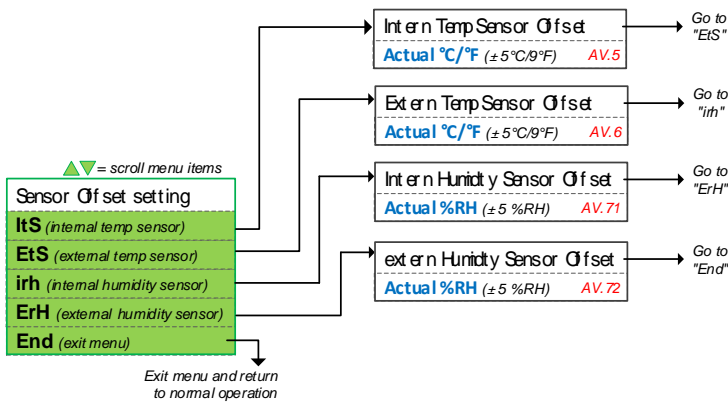

\*\*\* To save any changes, press on TFL and on TDF \*\*\*

\*\*\* To return to the previous step without saving, press on TFL and on TDF \*\*\*

### Menu 637 – Network Settings

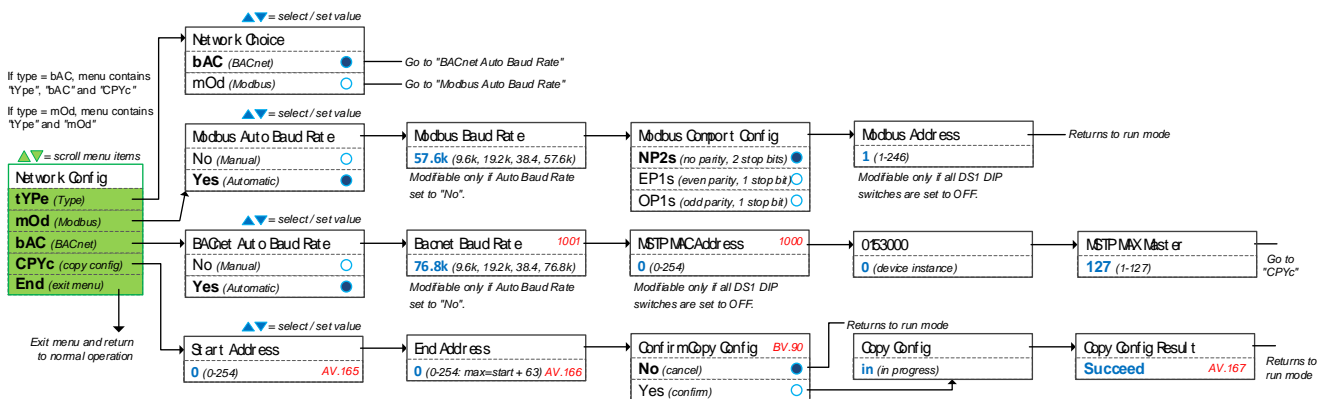

\*\*\* To save any changes, press on TFL and on TDF \*\*\*

\*\*\* To return to the previous step without saving, press on TFL and on TDF \*\*\*

## Reset to Factory Default Settings



This will erase all actual configurations and replace them with the factory default settings.

- The Mode Selector jumper (JP1) of the digital room sensor must be set to the "RUN" position (Operation Mode). Refer to Wiring on page 9.
- During the power up sequence of the controller and digital room sensor, press and hold both the [ / ] and buttons.
- The "Enter Password" screen appears. Enter **372** within 1 minute by using the arrow keys to increase or decrease the value and the [ / ] and [ / ] buttons to toggle between the digits.
- Use the arrow buttons to select YES and then press [ / ].



### Operation Mode

The Mode Selector Jumper of the digital room sensor must be set to the "RUN" position (Operation Mode). Refer to Wiring on page 9.

### TFL24

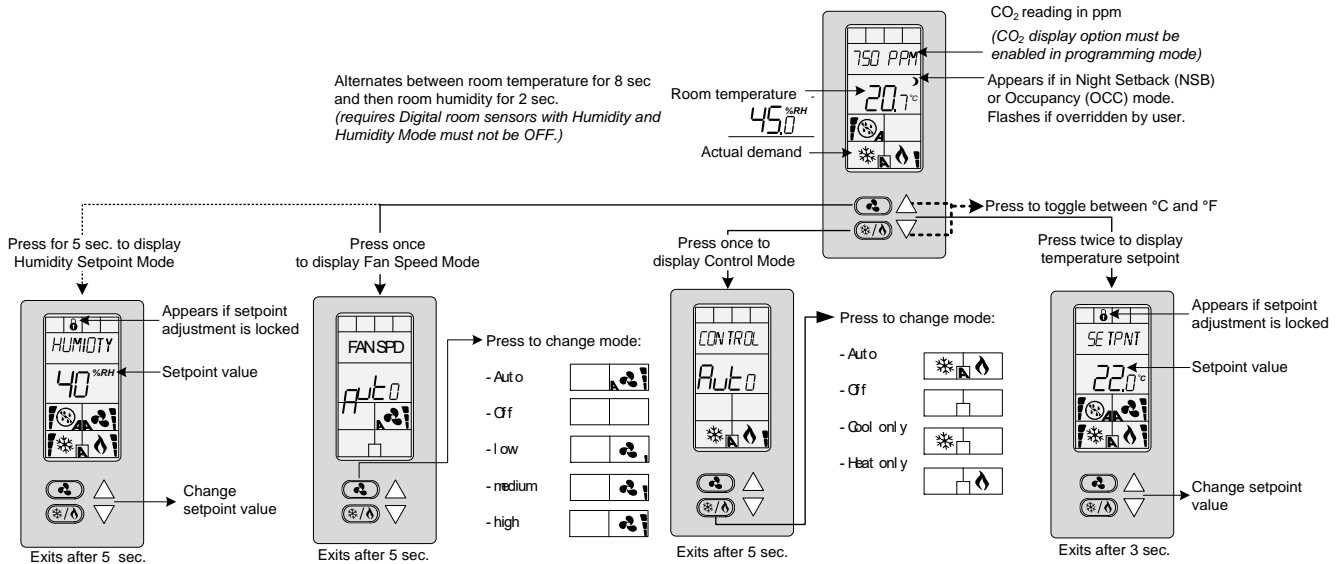

### TDF10 / TDF40 / TDF70 Series

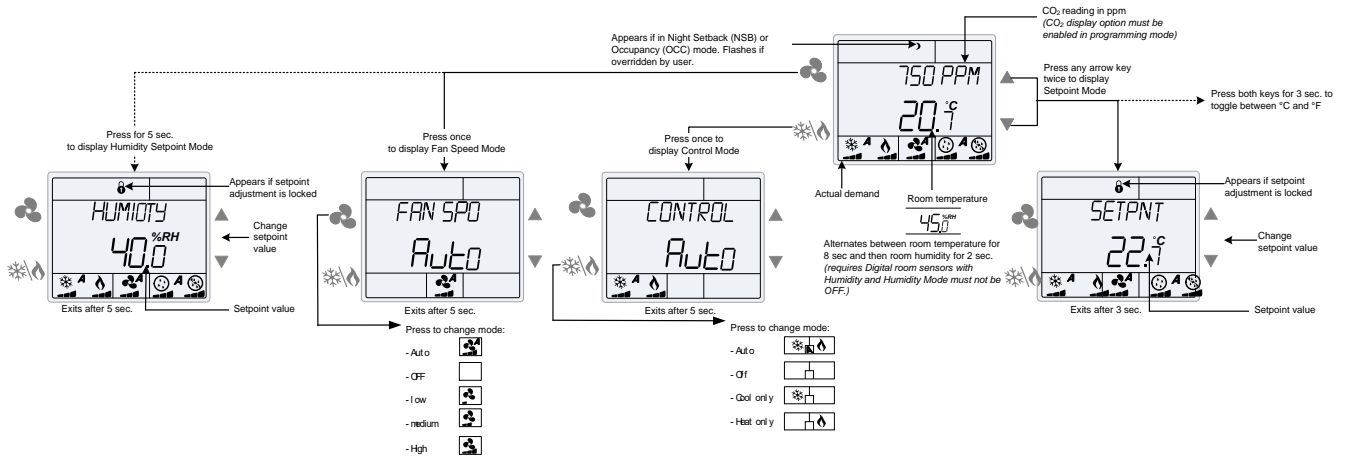

### TDF00 / TDF30 / TDF60 Series

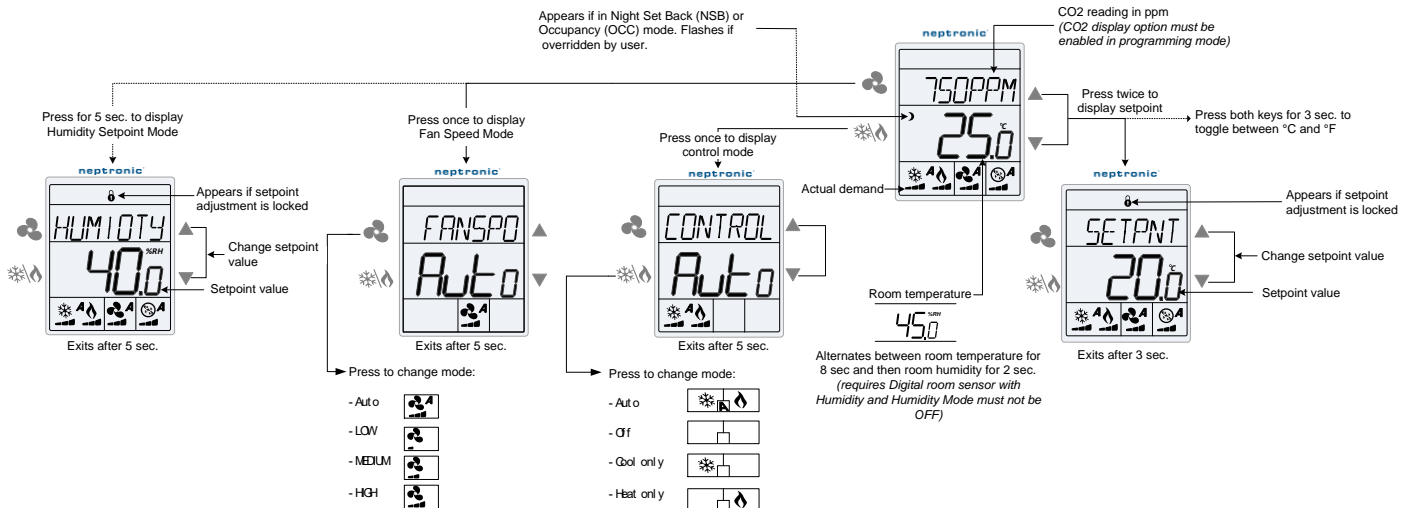



## Power Up

Upon power up, the LCD illuminates and all segments appear for 2 seconds. The digital room sensor then displays its current version for 2 seconds followed by the current version of the controller for 2 seconds. Pressing any key on the digital room sensor illuminates the LCD for 4 seconds.

## CO<sub>2</sub> (Digital Room Sensors with CO<sub>2</sub>)



If enabled via the configuration menu, the digital room sensor displays the CO<sub>2</sub> reading on the first line above the temperature reading. If CO<sub>2</sub> display is enabled, the time will not be displayed.

## Temperature Display and Setpoint





The digital room sensor displays the temperature reading. If the sensor is disconnected or short circuited, the unit displays the sensor's limits. To toggle the temperature scale between °C and °F, press both the ▲ and ▼ keys for 3 seconds. To display the setpoint, press the ▲ or ▼ key twice. The setpoint appears for 5 seconds. To adjust the setpoint, press the arrow keys while the temperature is displayed. If the setpoint adjustment has been locked, the lock  symbol appears.

## Temperature and Humidity (Digital Room Sensors with Temperature and Humidity)

The digital room sensor displays the temperature reading for 8 seconds and then displays the humidity reading for 2 seconds. If the sensor is disconnected or short circuited, the unit displays the sensor's limits. To toggle the temperature scale between °C and °F, press both the ▲ and ▼ keys for 3 seconds.





To access the Humidity setpoint, press the [ / ] button for 5 seconds. The humidity setpoint will be displayed for 5 seconds. To adjust the setpoint, press the ▲ and ▼ keys while the setpoint is displayed. The unit will return to normal mode if you do not press any key for 3 seconds. The changed values will be saved automatically.

## Control Mode

To access the Control Mode, press the [ / ] key. The Control Mode appears for 5 seconds. Press the [ / ] key to scroll through the following control modes. These options can vary depending on the options selected.



- Auto (Automatic Cooling or Heating)
- Cooling only (on, with cooling symbol)
- Heating only (on, with heating symbol)
- OFF (if it is not disabled in Programming Mode)

## Fan Speed Selection Mode

To access the Fan Speed selection mode, press the [ / ] key. The mode appears for 5 seconds. These options can vary depending on the fan speed signal and auto mode settings. If in No Occupancy mode, the [ / ] button now serves as the override button.

- Automatic speed. Available only if enabled in Programming Mode.
- Low speed
- Medium speed
- High speed
- Off. Off is not selectable by the user, it appears only if the "Control Mode" is "Off" and it indicates that the user can not change the speed of the fan.





## Night Setback (NSB)



This function is only available if you've set DI3 to **nSb** (Night setback contact). If the DI3 contact is triggered, the digital room sensor enters NSB Mode (the  symbol appears) and uses the NSB setpoints defined in Programming Mode. Press any key to override NSB for the delay defined in Programming Mode (default: 120 minutes). The  symbol flashes to indicate that the NSB mode is overridden (during this time the standard setpoints are used).

If the NSB Mode was set to OFF, all outputs will be off for the duration of the period and cannot be overridden.

## Occupancy Mode

This function is only available if you've set DI3 to **Occ** (occupancy mode). If the DI3 contact is triggered, the digital room sensor enters Occupancy Mode (the  symbol appears) and uses the NoOcc setpoints defined in Programming Mode.

If not locked, no occupancy mode can be overridden for a period by pressing the [ / ] button. Each time you press the [ / ] button, 15 minutes are added to the override (up to a maximum defined in program mode).

Press the fan [ / ] button until "0" is displayed to disable the override. The  icon will flash and the remaining override time will be displayed in minutes.



### Set Time and Date

1. Ensure that JP1 on the digital room sensor is set to run.
2. Press and hold the [ \* / Δ ] / [ \* / Δ ] button for 5 seconds.
3. Use the arrow keys to set the desired value. Press the [ ↻ ] / [ ↻ ] button to save and go to the next step. Press the [ \* / Δ ] / [ \* / Δ ] button to go to the previous step without saving.

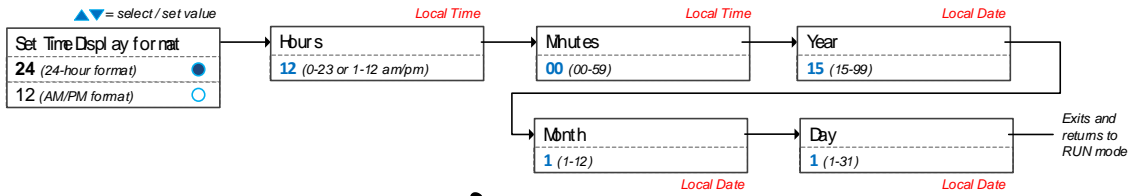

\*\*\* To save any changes, press [ ↻ ] on TFL and [ ↻ ] on TDF \*\*\*

\*\*\* To return to the previous step without saving, press [ \* / Δ ] on TFL and [ \* / Δ ] on TDF \*\*\*

Note: Time will only be displayed on the TDF when the Bacnet scheduler is active. In order to achieve this, set the proper BACnet Object present value to Yes (1): EFCB BV.91 – Cfg\_ActiveSchedule.



Recycling at end of life: please return this product to your Neptronic local distributor for recycling. If you need to find the nearest Neptronic authorized distributor, please consult [www.neptronic.com](http://www.neptronic.com).



**neptronic**<sup>®</sup>

400 Lebeau blvd, Montreal, Qc, H4N 1R6, Canada

[www.neptronic.com](http://www.neptronic.com)

Toll free in North America: 1-800-361-2308

Tel.: (514) 333-1433

Fax: (514) 333-3163

Customer service fax: (514) 333-1091

Monday to Friday: 8:00am to 5:00pm (Eastern time)