

# HVAC Controls For System Integrators



**neptronic®**



## Overview

Neptronic features a wide range of BTL listed BACnet MS/TP or Modbus networked controllers that have proven integration with several BMS systems on multiple sites around the world. Neptronic networkable controllers offer flexibility and simplicity within any integration strategy to provide:

- Seamless integration and interoperability
- Real-time information management and control
- Lower costs and higher value
- Diverse control strategies
- Higher energy conservation

## Save Time On Integration, Installation and Commissioning

Neptronic networkable controllers feature some or all of the following features and benefits.



### Two MAC Address Configuration Methods

Set MAC address via user friendly menu on thermostat or locally on unit via DIP switches.



### Firmware Upgrade via BACnet

Upgrade the device in the field via BACnet. Initiate the upgrade during normal operation and choose when to restart the system.



### Auto Configuration and Detection

The controller automatically configures its device instance to a default value + MAC address. The controller automatically configures its baud rate by detecting the network speed upon connection.



### Programming Schedules

Determine occupancy in advance for 7 days with up to 6 events per day. Avoid constant monitoring and save energy.



### Copy Configuration

Copy the controller's entire configuration and broadcast it to other controllers of the same type on the same network.



### Automatic Update of Changed Values

Enable subscription to update changed values automatically. Avoid regular polling of values, reduce traffic and transmit faster.



### BACnet Objects

Multiple BACnet Objects per controller enable you to read/write information as you monitor and trend status of operation, alarms and schedules.



### Service Display

If you are searching for a specific device, enabling the service mode will flash the device to easily locate the device.

**UMCP Frederick Hall,  
Maryland (USA)**



**AUTOMATEDLOGIC**  
United Technologies

370 TFCB  
Wall mount controllers

**Wilson Project,  
Sidney, OHIO (USA)**



**Thompson Tractor Company,  
Alabster, Alabama (USA)**



**BUILDINGLOGIX**  
BUILDING SYSTEMS INTERNATIONAL

65 EVCB  
Controllers

**International Civil Aviation Organization (ICAO),  
Montreal, Quebec (Canada)**



**Delta**  
CONTROLS  
A Delta Group Company

1100 EVCB  
Controllers

**INTEL PTK-1 R&D Center,  
Petach Tikva (Israel)**



**GE**

700 EFCB  
Controllers

**Rashid Hospital,  
Dubai (UAE)**



**Honeywell**

240 EVCB  
Controllers

**Funan Digitalife Mall,  
Singapore**



**Johnson  
Controls**

950 TUCB  
450 CMMB106  
Controllers

**Google Offices Tel-Aviv,  
Israel**

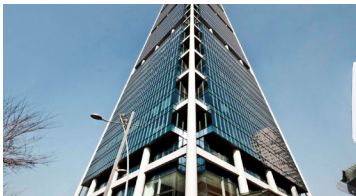

**Schneider  
Electric**

700 EFCB  
Controllers

**Jurong Port,  
Singapore**



**Schneider  
Electric**

700 EVCB  
Controllers

**Landmark 81,  
Vietnam**



**SIEMENS**

700 EVCB  
Controllers

**Palm Tower,  
Qatar**



**TREND**

1600 EVCB  
Controllers

**World Business Center  
Heathrow Airport London (UK)**

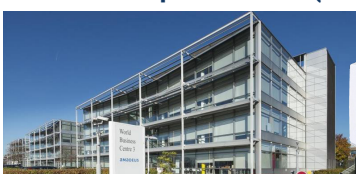

**TRIDIUM**

200 EFCB  
Controllers

**Google Campus,  
India**



**TRIDIUM**

350 EVCB  
Controllers





ASHRAE **BACnet™**

**Modbus**



Fan coil unit controller (EFCB) with Digital Room Sensor (TDF)



## Inputs

**DI4**

4 Digital\*

**AI6**

6 Analog\*



24Vac  
120/240Vac

## Outputs

**BO8**

4 TRIACs  
Up to 4 Digital\*

**A04**

4 Analog\*



1, 2, or 3\* Speed  
or ECM

## Communication

**BAC**

BACnet  
MS/TP

\*Configurable

**Mod**

Modbus  
RTU Slave



Room Sensor  
3 Wires (Digital)

## Models

Model	Type	Extra 3A Relay
EFCB10TU2	24Vac	2
EFCB10TU4		4
EFCB11TU2	120Vac	2
EFCB11TU4		4
EFCB12TU2	240Vac	2
EFCB12TU4		4
<b>Middle East and Asian Markets</b>		
EFCB10T-OE1	24Vac	0
EFCB10TU2-OE1		2
EFCB10TU4-OE1		4
EFCB12T-OE1	240Vac	0
EFCB12TU2-OE1		2
EFCB12TU4-OE1		4

## Controller (EFCB)

- Real Time Clock (RTC) with 24 hour backup
- Configurable PI (Proportional-Integral) function
- Selectable proportional control band and dead band
- Independent cool/heat setpoint for NSB/OCC mode
- Selectable internal or external temperature sensor (10KΩ)
- Change over by contact or external temperature sensor
- Freeze protection
- BACnet MS/TP or Modbus communication (selectable)
- BACnet scheduler
- Firmware upgradeable via BACnet
- 4 AI can be configured as Dry Contacts
- Digital room sensor with onboard or external CO<sub>2</sub> sensor with integrated logic
- ECM with Enable/Disable option

## Applications

- 2 or 4 pipe systems
- Fan coil unit (up to 3 speeds and/or analog 0-10Vdc)
- Cooling signal (on/off, floating or modulating 0-10Vdc)
- Heating signal (on/off, floating, pulse or modulating 0-10Vdc)
- Reheat signal (on/off, floating, pulse or modulating 0-10Vdc)





**NEW**



● TDF10



● TDF40



○ TDF70



● TDF00



● TDF30



○ TDF60

## Models



Horizontal Models	Temp.	RH	CO <sub>2</sub>
● TDF10-100 ● TDF40-100 ○ TDF70-100	•		
● TDF10-101 ● TDF40-101 ○ TDF70-101	•	•	
● TDF10-102 ● TDF40-102 ○ TDF70-102	•	•	•
● TDF10-103 ● TDF40-103 ○ TDF70-103	•		•

Vertical Models	Temp.	RH	CO <sub>2</sub>	PIR	VOC
● TDF00-100 ● TDF30-100 ○ TDF60-100	•				
● TDF00-101 ● TDF30-101 ○ TDF60-101	•	•			
● TDF00-102 ● TDF30-102 ○ TDF60-102	•	•	•		
● TDF00-104 ● TDF30-104 ○ TDF60-104	•			•	
● TDF00-105 ● TDF30-105 ○ TDF60-105	•	•		•	
● TDF00-106 ● TDF30-106 ○ TDF60-106	•	•	•		•
● TDF00-107 ● TDF30-107 ○ TDF60-107	•	•	•	•	•
● TDF00-108 ● TDF30-108 ○ TDF60-108	•	•	•	•	

## Universal Digital Room Sensor (TDF)

- Built-in temperature sensor and optional humidity, CO<sub>2</sub>, VOC and occupancy sensors (select models)
- Elegant design
- Universal wall-mount design
- Used to configure and operate the EFCB Fan Coil controllers
- Three wire connection between digital room sensor and controller
- Selectable Fahrenheit or Celsius scale
- BACnet service port via on-board mini USB connector
- Horizontal or vertical configuration

# TSUB



# Fan Coil Wall Mount Controller

**NEW**



## Inputs

**AI2**

2 Analog\*  
(Universal)



24Vac

## Outputs

**B05**

5 Binary\*

**A02**

2 Analog\*



1, 2, or 3\* Speed  
or ECM

## Communication

**BAC**

BACnet  
MS/TP

**Mod**

Modbus  
RTU Slave

\*Configurable

## Models

Models	Temp.	RH	PIR
<ul style="list-style-type: none"> <li>● TSUB00-100</li> <li>● TSUB30-100</li> <li>○ TSUB60-100</li> </ul>	.		
<ul style="list-style-type: none"> <li>● TSUB00-101</li> <li>● TSUB30-101</li> <li>○ TSUB60-101</li> </ul>	.	.	
<ul style="list-style-type: none"> <li>● TSUB00-104</li> <li>● TSUB30-104</li> <li>○ TSUB60-104</li> </ul>	.		.
<ul style="list-style-type: none"> <li>● TSUB00-105</li> <li>● TSUB30-105</li> <li>○ TSUB60-105</li> </ul>	.	.	.

## Main Features

- Optional internal/external humidity sensor input for simple and accurate humidity control
- External occupancy input
- Dehumidification sequence compensated by auto activation of reheat output
- Real time clock (RTC) with 24-hour backup
- Precise temperature control with configurable PI (Proportional-Integral) function
- Selectable internal or external temperature sensor
- Low limit set protection (10°C/50°F)
- Occupancy and night set back (NSB) mode
- Selectable direction on outputs
- Option of pulse/floating/on-off output on binary outputs
- Compressor anti-cycling delay (configurable)
- ΔT control (on request)
- Selectable BACnet MS/TP or Modbus communication
- Selectable Fahrenheit or Celsius scale
- Multi level lockable access menu and setpoint

# TSU



## Fan Coil Standalone Wall Mount Controller

**NEW**



### Inputs

**A12**

2 Analog\*  
(Universal)



24Vac

### Outputs

**B05**

5 Binary\*

**A02**

2 Analog\*



1, 2, or 3\* Speed  
or ECM

\*Configurable

### Models

Models	Temp.	RH	PIR
● TSU00-110	•		
● TSU00-111	•	•	
● TSU00-114	•		•
● TSU00-115	•	•	•

### Main Features

- Optional internal/external humidity sensor input for simple and accurate humidity control
- External occupancy input
- Dehumidification sequence compensated by auto activation of reheat output
- Precise temperature control with configurable PI (Proportional-Integral) function
- Selectable internal or external temperature sensor
- Real time clock (RTC) with 24-hour backup
- 7-day programmable schedule

# CCC



## Fan Coil Relay Interface Board



### Models

Model	Voltage	Contact Ratings		Number of Outputs
		Resistive	Motor	
CCC713-07	120 Vac	7 A	1/4 HP	3
CCC714-07				4
CCC715-07				5
CCC723-07	240 Vac	7 A	1/4 HP	3
CCC724-07				4
CCC725-07				5

### Main Features

- 240/120 Vac
- 3, 4 or 5 contacts
- Metal box with secure 4-point mounting (models without enclosure also available)
- Equipped with built-in transformer (12VA max)

### Applications

- Ideal for fan coil applications where 240/120 Vac equipment must be controlled by a 24Vac digital room sensor
- Designed to operate with TFC, TUCB, TSU, TSUB and TUUB controllers



# EVCB



# VAV Unit Controller



VAV unit controller (EVCB) with Digital Room Sensor (TDU)

## Inputs

<b>DI2</b>	<b>AI2</b>		
2 Digital*	2 Analog*	Pressure Sensor (select models)	24Vac

## Outputs

<b>B04</b>	<b>A02</b>
Up to 4 TRIACs	2 Analog*

## Communication

<b>BAC</b>	<b>Mod</b>	
BACnet MS/TP	Modbus RTU Slave	Room Sensor 3 Wires (Digital)

\*Configurable

## Models

Model	TRIACS	Pressure Type	Feedback	Fan Powered Box
EVCB14NIT0S	0	Indep.		
EVCB14NIT2S	2	Indep.		
EVCB14NIT4S	4	Indep.		•
EVCB14NDT4S	4	Dep.		•
EVCB14NIT0SF	0	Indep.	•	
EVCB14NIT4SF	4	Indep.	•	•

## External Motor

Model	TRIACS	Pressure Type	Motor
EVCB14NIT4X	4	Indep.	External
EVCB14NDT4X	4	Dep.	External

## Controller (EVCB)

- Built-in actuator, 70 in.lb. (8Nm) (select models)
- On board differential pressure sensor (select models)
- Simple air balancing and commissioning via digital room sensor
- Automatically sets operation mode to pressure dependent or independent based on the presence of air flow
- Configurable PI (Proportional-Integral) function
- Independent, configurable proportional control band and dead band per ramp
- Selectable internal or external temperature sensor (10KΩ)
- Digital room sensor with on-board or external CO<sub>2</sub> sensor with integrated logic
- Changeover by contact or external temperature sensor
- Real time clock (RTC) with 24-hour backup
- BACnet MS/TP or Modbus communication (selectable)
- BACnet scheduling

## Applications

- Single duct, cooling only and/or heating
- Up to 4 stage reheat and/or cool
- Up to 4 On/Off heat and/or cool
- Up to 4 time proportioned (TPM) heat or reheat
- Up to 2 analog (0-10Vdc) reheat and/or cool
- Up to 2 floating heat and/or cool
- Pressure dependent or pressure independent
- With or without auto changeover
- Supply/exhaust (requires an additional EVC)

# TDU



# VAV Digital Room Sensors

**NEW**



● TDU10

● TDU40

○ TDU70



● TDU00

● TDU30

○ TDU60

## Models



Horizontal Models	Temp.	RH	CO <sub>2</sub>
● TDU10-100 ● TDU40-100 ○ TDU70-100	•		
● TDU10-101 ● TDU40-101 ○ TDU70-101	•	•	
● TDU10-102 ● TDU40-102 ○ TDU70-102	•	•	•
● TDU10-103 ● TDU40-103 ○ TDU70-103	•		•

Vertical Models	Temp.	RH	CO <sub>2</sub>	PIR	VOC
● TDU00-100 ● TDU30-100 ○ TDU60-100	•				
● TDU00-101 ● TDU30-101 ○ TDU60-101	•	•			
● TDU00-102 ● TDU30-102 ○ TDU60-102	•	•	•		
● TDU00-104 ● TDU30-104 ○ TDU60-104	•			•	
● TDU00-105 ● TDU30-105 ○ TDU60-105	•	•		•	
● TDU00-106 ● TDU30-106 ○ TDU60-106	•	•	•		•
● TDU00-107 ● TDU30-107 ○ TDU60-107	•	•	•	•	•
● TDU00-108 ● TDU30-108 ○ TDU60-108	•	•	•	•	

## Universal Digital Room Sensor (TDU)

- Built-in temperature sensor and optional humidity, CO<sub>2</sub>, VOC and occupancy sensors (select models)
- Elegant design
- Universal wall-mount design
- Used to configure and operate the EVCB VAV controllers
- Three wire connection between digital room sensor and controller
- Selectable Fahrenheit or Celsius scale
- BACnet service port via on-board mini USB connector
- Horizontal or vertical configuration

# TRO24/TRO54



# VAV Wall Mount Controller



## TRO24



Combination VAV controller and room thermostat.  
Run control wires directly to TRO unit.



## BACnet Model

Model	Options
TROB24T4XYZ1	BACnet

## Stand-Alone Models

Model	Options
TRO24T4XYZ1	
TRO24T4XYZ3	Scheduler
TRO24-EXT1	Extended setpoint range

## Applications

Ideal for existing installations and retrofits that already have an actuator mounted on the VAV box.



## TRO54 Stand-Alone Models

Model	Analog outputs	TPM/Digital outputs	Sensor inputs
TRO5404	4	1 TPM	2
TRO54P3X1	2	3 Digital	2
<b>Middle East and Asian Markets</b>			
TRO5404-OE1	4	1 TPM	2

## Inputs

### AI3

3 Analog\*



24Vac

## Outputs

### BO4

4 TRIACs\*

### A02

2 Analog\*

## Communication

### BAC

BACnet  
MS/TP

\*Configurable

## Main Features

- Programmable PI function
- Selectable proportional control band and dead band
- Pressure sensor input with air flow program
- Selectable internal or external temperature sensor
- Changeover by contact or external temperature sensor
- Freeze protection
- Backlit LCD with simple icon and text driven menus
- Selectable Fahrenheit or Celsius scale
- Manual Night set back override
- Multi level lockable access menu and setpoint

## Main Features

- 24Vac operation
- Backlit LCD with simple icon and text driven menus
- Selectable Fahrenheit or Celsius scale
- "Night Set Back" mode with manual override
- Multi level lockable access menu and setpoint
- Selectable internal or external temperature sensor
- Selectable proportional control band



# TUUB



# Universal Wall Mount Controller

**NEW**



Packaged AC Rooftop Units



Heat Pumps



Fan Coils

## Inputs

**A14**

4 Analog\*  
(Universal)



24Vac

## Outputs

**B06**

6 Binary\*

**A04**

4 Analog\*



1, 2, or 3\* Speed  
or ECM

## Communication

**BAC**

BACnet  
MS/TP

**Mod**

Modbus  
RTU Slave

\*Configurable

## Models

Models	Temp.	RH	CO <sub>2</sub>	PIR	VOC
● TUUB00-200 ● TUUB30-200 ○ TUUB60-200	•				
● TUUB00-201 ● TUUB30-201 ○ TUUB60-201	•	•			
● TUUB00-202 ● TUUB30-202 ○ TUUB60-202	•	•	•		
● TUUB00-203 ● TUUB30-203 ○ TUUB60-203	•		•		
● TUUB00-204 ● TUUB30-204 ○ TUUB60-204	•			•	
● TUUB00-205 ● TUUB30-205 ○ TUUB60-205	•	•		•	
● TUUB00-206 ● TUUB30-206 ○ TUUB60-206	•	•	•		•
● TUUB00-207 ● TUUB30-207 ○ TUUB60-207	•	•	•	•	•

## Main Features

- Optional internal/external humidity sensor input for simple and accurate humidity control
- External occupancy input
- Optional built-in CO<sub>2</sub> and VOC sensors
- Output selector jumper to switch between B07 and A01
- Dehumidification sequence compensated by auto activation of reheat output
- Real time clock (RTC) with 24-hour backup
- Precise temperature control with configurable PI (Proportional-Integral) function
- Selectable internal or external temperature sensor
- Low limit set protection (10°C/50°F)
- Occupancy and night set back (NSB) mode
- Selectable direction on outputs
- Option of pulse/floating/on-off output on binary outputs
- Internal/external occupancy input
- Compressor anti-cycling delay (configurable)
- ΔT control (on request)
- BACnet MS/TP or Modbus communication (selectable)

## Universal Applications

- Fan coil units (2 or 4 pipes)
- Rooftop units
- Heat pumps
- Humidity control
- Packaged or split unitary systems
- Other heating/cooling equipment

# ARO/AROB



## IAQ Wall Mount Controller

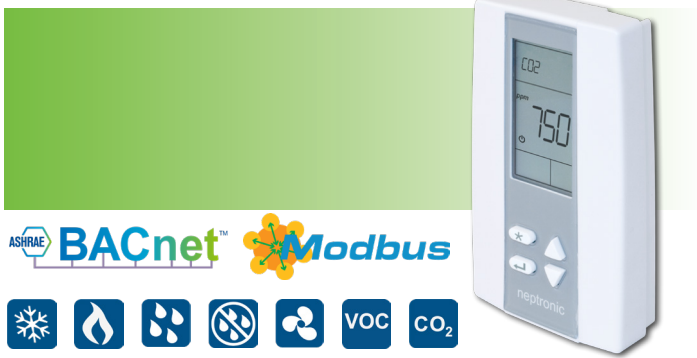

ASHRAE **BACnet™** **Modbus**



### Stand-Alone Models

Model	Temp.	RH	CO <sub>2</sub>	VOC
ARO24T	•			
ARO24TH	•	•		
ARO24TGH	•	•	•	
ARO24TGVH	•	•	•	•

### Networkable Models

Model	Temp.	RH	CO <sub>2</sub>	VOC
AROB24T	•			
AROB24TH	•	•		
AROB24TGH	•	•	•	
AROB24TGVH	•	•	•	•

### Inputs

**BI1**

1 Binary\*

**AI1**

1 Analog

### Outputs

**B02**

2 Binary\*

**A02**

2 Analog\*



ECM

### Communication

**BAC**

BACnet  
MS/TP

\*Configurable

**Mod**

Modbus  
RTU Slave

### Main Features

- Built-in application profiles to automatically configure the controller for the selected application.
- Up to 4 simultaneous control loops
- Integrated ECM fan control mode
- Displays temperature, %RH, CO<sub>2</sub>, VOC, and setpoints
- Display or hide all the required access for user interaction
- Precise temperature control with programmable PI function
- Independent cool and heat setpoint for No Occupancy

# HROB20



## Humidity Control Wall Mount Controller



ASHRAE **BACnet™**



### Applications

- Nepronic SKR, SKE4, SKS4, and SKG4 humidifiers
- Other humidification and dehumidification applications

### Main Features

- BACnet MS/TP (stand-alone model HRO20 also available)
- 4 analog outputs and 2 dry contact outputs
- 2 configurable analog inputs
- Window or external temperature sensor input
- Alarm status and low signal selector input
- Independently configure PID on humidify & dehumidify ramps
- Adjustable setpoint with auto reset from external sensor
- Multi level lockable access menu, setpoint and control mode

# CMMB100

I/O

## Dual Mini Input Module Expansion Controller

NEW



ASHRAE BACnet™

Modbus

Input expansion board (CMMB)

UL LISTED CE

BTL

### Inputs

**A18**

8 Analog\*  
(Universal)



24Vac/  
24Vdc

### Communication

**BAC**

BACnet  
MS/TP

\*Configurable

**Mod**

Modbus  
RTU Slave

### Main Features

- BACnet MS/TP or Modbus communication (selectable)
- LED status indication of each input
- DIN rail mounting
- Removable see-through panel for easy access to DIP switches

### Models

Model	Inputs
CMMB100	8

# CMMB102

I/O

## Dual Mini I/O Module Expansion Controller

NEW



ASHRAE BACnet™

Modbus

Input and output expansion board (CMMB)

UL LISTED CE

BTL

### Inputs

**A14**

4 Analog\*  
(Universal)



24Vac/  
24Vdc

### Outputs

**B02**

2 Binary\*

**A02**

2 Analog\*  
(Universal)

**SW**

4 Override  
Switches

### Communication

**BAC**

BACnet  
MS/TP

\*Configurable

**Mod**

Modbus  
RTU Slave

### Models

Model	Inputs	Outputs
CMMB102	4	4

### Main Features

- BACnet MS/TP or Modbus communication (selectable)
- 4 override switches to manually control each output
- LED status indication of each input and output
- DIN rail mounting
- Removable see-through panel for easy access to DIP switches



# CMMB106

I/O

## Dual Pro I/O Module Expansion Controller



ASHRAE **BACnet™**

**Modbus**

**Input and output expansion board (CMMB)**

CE

BTL

UL LISTED

### Inputs

**DI2**

2 Digital\*

**AI8**

8 Analog\*  
(Universal)



24Vac/  
30Vdc

### Outputs

**DO6**

6 Digital\*

**AO4**

4 Analog\*

**SW**

10 Override  
Switches

### Communication

**BAC**

BACnet  
MS/TP

\*Configurable

**Mod**

Modbus  
RTU Slave

### Models

Type	Model	Buttons	Inputs	Outputs
Exp. Board	CMMB106		10	10
Thermostat	STLD24A	Fan & heat-cool	1	
Thermostat	STLD24B	Fan & °F/°C	1	

### Expansion Board (CMMB)

- BACnet MS/TP or Modbus communication (selectable)
- 10 inputs and 10 supervised outputs
- 10 override switches to manually control each output
- LED status indication of each input and output
- DIN rail mounting

### Room Thermostat (STLD)

- User Interface fully customizable via Modbus RTU
- Backlit LCD with simple icon and text driven menus
- Built-in temperature sensor
- External temperature sensor input (10 KΩ)
- Selectable Fahrenheit or Celsius scale
- Set Modbus RTU baud rate via thermostat menu (9600, 19200, 38400 or 57600 bps)
- Set Modbus RTU address via thermostat menu or via DIPswitch

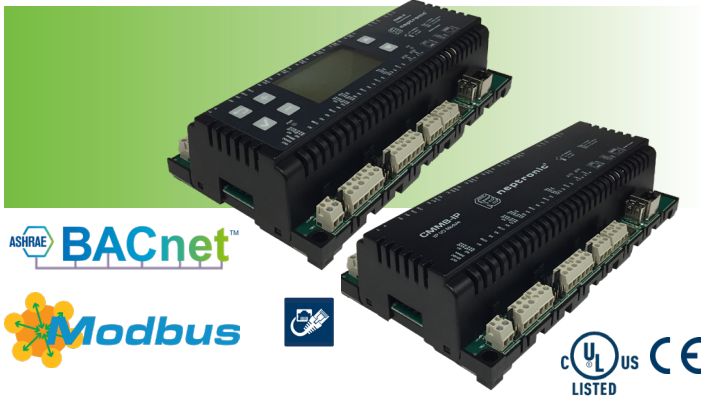

## Inputs

### BI2

2 Binary\*

### AI8

8 Analog\*  
(Universal)



24Vac/  
24Vdc

## Outputs

### BO6

6 Binary\*

### AO4

4 Analog\*

### SW

10 Override  
Switches

## Models

Model	Router	Display	Communication Ports	
			BACnet Ports	Modbus Ports
CMMB-IP			1	1
CMMB-IP-L		•	1	1
CMMB-IP-R1B	•		1	
CMMB-IP-R2B	•		2	
CMMB-IP-RL1B	•	•	1	
CMMB-IP-RL2B	•	•	2	

## Communication

### BAC

BACnet  
MS/TP, IP  
*\*Configurable*

### Mod

Modbus  
RTU Slave,  
TCP/IP

### IP

IP  
Network &  
Web Services

## Features

### Power & Communication

- 24Vac or 24Vdc supply
- Up to 2 RS-485 communication ports for BACnet MS/TP or Modbus RTU
- BACnet IP/Ethernet or Modbus TCP/IP
- Set network settings via embedded WEB server
- Provision for I/O expansion modules
- Router functionality (optional)

### 10 Inputs

- 2 binary inputs
- 8 universal inputs

### 10 Outputs

- 6 binary outputs
- 4 analog outputs
- Supervised manual override of outputs via local web page or local dip switches

### Other

- SD card slot for updates
- USB port for 5 Vdc power supply
- RJ45 Ethernet connection for IP and WEB services
- Optional LCD display

## Network Communication

### BACnet MS/TP

- MS/TP @ 9600, 19200, 38400 or 76800 bps
- Automatic baud rate detection
- Automatic device instance configuration

### BACnet IP/Ethernet

- All IP/Ethernet configuration via on board WEB page
- Display device status including each available data point, in addition to the BACnet object interface
- Supports DHCP or fixed/static addressing

### Modbus RTU

- Modbus @ 9600, 19200, 38400 or 57600 bps
- RTU Slave, 8 bits (configurable parity and stop bits)
- Connects to any Modbus master

### Modbus TCP/IP

- Connects to any Modbus TCP/IP master controller

# CMMB1020



# Remote I/O Expansion Controller



## Inputs

**UI30**

30 Universal

24Vac/  
24Vdc

## Outputs

**B012**

12 Binary

**A04**

4 Analog

**U04**

4 Universal

## Communication

**BAC**

BACnet  
MS/TP

**Mod**

Modbus  
RTU Slave

## Models

Type	Inputs	Outputs
CMMB1020	30	20

## Network Communication

- BACnet® MS/TP or Modbus communication ports (selectable via DIP switch)
- Select MAC address via DIP switch or via network

### BACnet®

- MS/TP @ 9600, 19200, 38400, 76800 or 115000 bps
- Automatic baud rate detection
- Automatic device instance configuration
- Improved BACnet Stack
- Firmware upgradable via BACnet
- Expansion slot for connection to Neptronic RPB BACnet Router

### Modbus

- Modbus @ 9600, 19200, 38400 or 57600 bps
- RTU Slave, 8 bits (configurable parity and stop bits)
- Connects to any Modbus masterExpansion slot for connection to Neptronic RPB BACnet Router

## Features

### Power & Communication

- 24Vac or 24Vdc supply
- BACnet® MS/TP or Modbus communication port (selectable)

### Inputs & Outputs

- 30 universal inputs
- 4 universal outputs
- 4 analog outputs
- 12 binary outputs

### Installation

- LED status indication of each output
- DIN rail mounting
- Removable, non-strip, raising clamp terminals

### Other

- 16-bit A/D Converter for greater resolution
- Supports Pt1000 and Ni1000

# CMMB1322

I/O

## Mini I/O Module Expansion Controller



ASHRAE BACnet™



**Input and output expansion board (CMMB)**

### Models

Type	Network	Inputs	Outputs
CMMB1322	BACnet MS/TP	2	2

### Main Features

- BACnet MS/TP
- 2 inputs and 2 supervised outputs
- 2 override switches to manually control each output
- 120Vac or 240 Vac selectable power input
- 2 auxiliary outputs (24Vdc / 24Vac)

### Inputs

**AI2**

2 Analog\*  
(Universal)



120 or 240Vac  
(selectable)

### Outputs

**BO2**

2 Binary\*

**SW**

2 Override  
Switches



24Vdc and 24Vac  
(aux. output)

### Communication

**BAC**

BACnet  
MS/TP

\*Configurable

# RPB



## BACnet Router



ASHRAE BACnet™



### Models

Model	Description	Devices
RPB11	1-Port BACnet	Up to 32
RPB12	2-Port BACnet	Up to 64

### Main Features

- 24Vac or 24Vdc supply
- Up to 32 or 64 BACnet devices without the use of additional line drivers
- Simple web based configuration for BACnet IP and MS/TP communication

### Power



24VDC

### Communication

**BAC**

BACnet  
MS/TP, IP

- Connect using expansion slot to convert CMMB100E and CMMB102E as IP I/O cards
- Support up to 3 mini I/O cards in any combination and make them IP ready while maintaining the MS/TP ports for BACnet routing

# Typical System Architecture

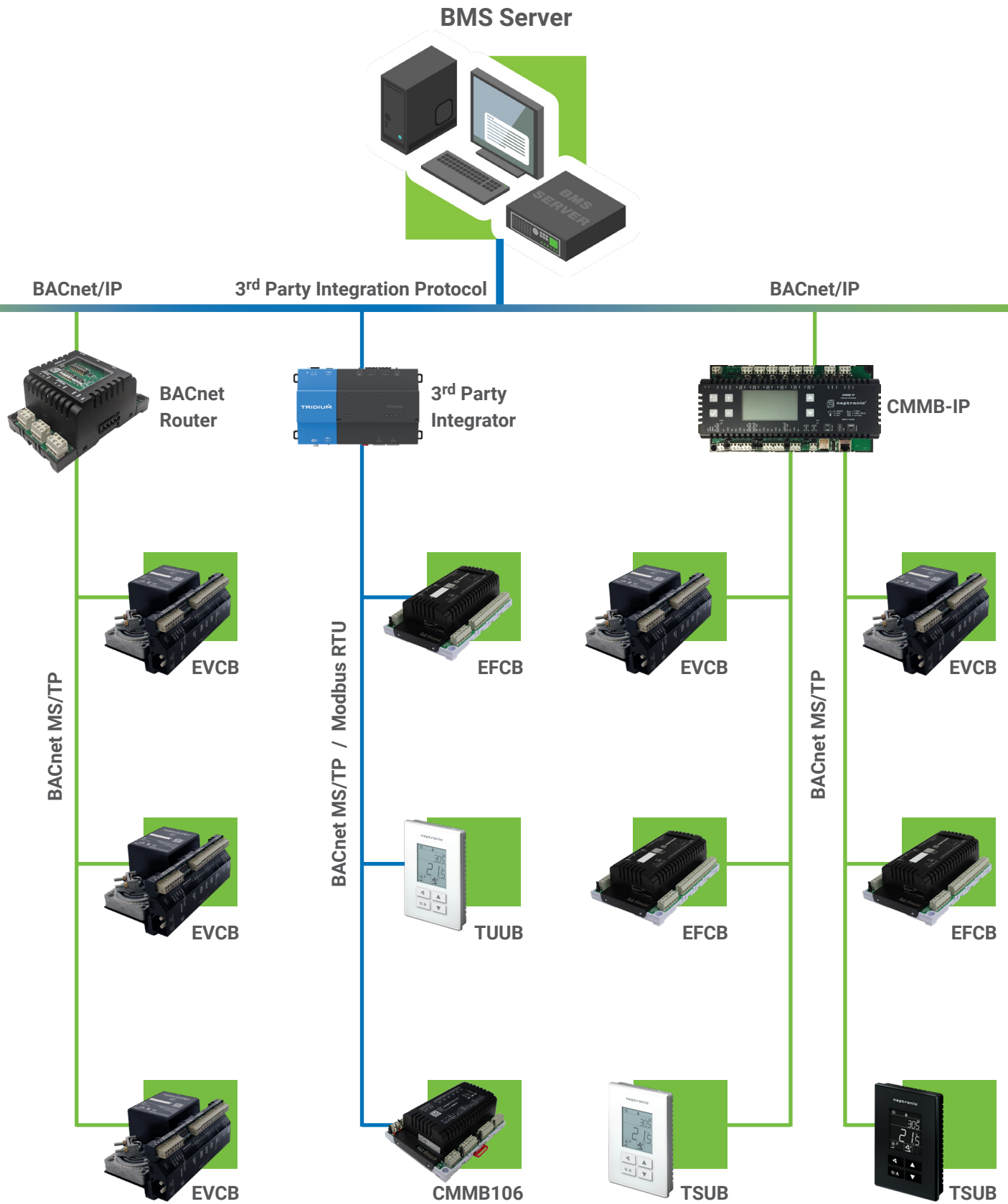



# SARB



## Networkable IAQ Room Sensors



### Models

Model	Temp.	RH	CO <sub>2</sub>	VOC
SARB24T	•			
SARB24TH	•	•		
SARB24TG	•		•	
SARB24TV	•			•
SARB24TGH	•	•	•	
SARB24TGVH	•	•	•	•

### Inputs

**BI1**

1 Binary

**AI1**

1 Analog



24Vdc/  
24Vac

### Outputs

**BO2**

2 Binary\*

**AO2**

2 Analog\*

### Communication

**BAC**

BACnet  
MS/TP

**Mod**

Modbus  
RTU Slave

\*Outputs commandable via network

### Main Features

- 2 inputs and 4 outputs commandable via network
- Enthalpy and dew point calculations (available via network)
- Display or hide all the required access for user interaction
- Backlit LCD with simple icon and text-driven menus
- Selectable Fahrenheit or Celsius scale
- BACnet® MS/TP or Modbus (selectable via menu)
- Select MAC address via menu or via network
- Automatic baud rate detection
- Network service port via on-board mini USB connector

# SAR



## IAQ Room Sensors



### Models

Model	Temp.	RH	CO <sub>2</sub>	VOC
SAR24GH		•	•	
SAR24GV			•	•

### Main Features

- CO<sub>2</sub> sensor feedback output (A01)
- CO<sub>2</sub> warning and alarm level outputs (BO1 and BO2)
- Humidity or VOC sensor feedback output (A02)
- Input voltage 24Vac or 24Vdc

# Sensors



# Humidity



### SHC80: Duct Mount Humidity Sensor

- Duct mounted humidity sensor
- Built-in temperature sensor
- 2 analog outputs (0 - 10 Vdc)
- Status LED



### SHR10: Wall Mount Humidity Sensor

- Wall mounted humidity sensor
- Built-in temperature sensor
- Plastic cover for wall mount installation
- 2 analog outputs (0 - 10 Vdc)
- High accuracy and stability

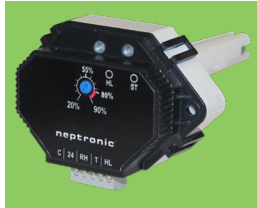

### SHS80: Duct Mount, High Limit Humidistat

- Built-in temperature and humidity sensor
- On/Off high limit humidistat with on-board setpoint adjustment
- 2 analog outputs (0-10 Vdc)
- Status and high limit LEDs
- 1 dry contact output



### HRL24: Room Humidistat

- Used to program the SK4 series humidifiers
- Icon-driven information and 1 line of text information
- 4 wires between humidistat and SK4
- Programmable PID on humidity



### SHS20: Room High Limit Humidistat

- High-limit setpoint dial (20 - 90% RH)
- Built-in humidity sensor
- 24Vac or 24Vdc
- 1 dry contact output



### HRC20: Room Humidistat

- Humidity setpoint dial (10-60 %RH)
- Built-in humidity sensor
- 24Vac or 24Vdc
- 1 dry contact output

# Sensors



# Pressure



Model	Pressure Range
SPC 0.1	0 to 0.1" w.c.[25 Pa]
SPC 1.0	0 to 1.0" w.c.[250 Pa]
SPC 2.0	0 to 2.0" w.c.[500 Pa]
SPC 5.0	0 to 5.0" w.c.[1245 Pa]

### SPC: Static Pressure Controller

- Simple installation and configuration
- Displays actual pressure reading
- Adjustable setpoint, dead band and response speed
- Selectable output signal
- Direct or reverse action outputs
- Fully calibrated
- Real-time pressure output for remote monitoring



Model	Pressure Range	Enclosure
SPD00-010	0-1" w.c.[250 Pa]	PCB only
SPD70-010	0-1" w.c.[250 Pa]	Metal enclosure
SPD00-020	0-2" w.c.[500 Pa]	PCB only
SPD70-020	0-2" w.c.[500 Pa]	Metal enclosure
SPD00-050	0-5" w.c.[1245 Pa]	PCB only
SPD70-050	0-5" w.c.[1245 Pa]	Metal enclosure

### SPD: Static Pressure Differential Transducer

- Small footprint
- Simple and easy to install
- Selectable output signal (0-10 or 2-10 Vdc & 4-20 or 0-20mA)
- High flow impedance in the range of tens to hundreds of kPa

# Sensors



# Temperature



## STC8: Duct Mount Temperature Sensor

- High accuracy and stability
- Fast thermal response
- Epoxy encapsulated sensor
- Extended durability
- Resistor/Temperature Curve
  - "G" matched (STC8-11, 10K $\Omega$ )
  - "A" matched (STC8-13, 3.3 K $\Omega$ )
- Compatible with Nepronic controllers

STC8-11	10K $\Omega$
STC8-13	3.3K $\Omega$
STC80X	Analog



## STR1: Wall Mount Temperature Sensor

- Available with 10K $\Omega$  or 3.3K $\Omega$  thermistor
- High accuracy and stability
- Negative Temperature Coefficient (NTC)
- Compatible with Nepronic products

STR1-11	10K $\Omega$
STR1-13	3.3K $\Omega$



## STP: Strap-On Water Temperature Sensor

- High accuracy and stability
- 10K $\Omega$  Type III Thermistor
- Designed for fan coil 2 pipe changeover applications
- Sensitive to non-polarity
- Temperature range: -40°C to 150°C (-40°F to 302°F)

STP7-11	Metal
STP1-11	Plastic



## STI1-11: Immersion Water Temperature Sensor

- 10K $\Omega$  Type III Thermistor
- Immersion type temperature sensor
- Double encapsulation sensor eliminates moisture infiltration
- Machined 5 Brass thermowell
  - ABS plastic enclosure
  - Quick snap latch



## OTW/SHW: Window Temperature Sensor

- 10K $\Omega$  (SHW0-11) or 3.3K $\Omega$  (OTW) temperature sensor
- Self adhesive: sticks directly on window

# Accessories



## CVC

- 24Vac or 24 Vdc supply
- 2 or 4 SPDT relays (staged or sequenced operation)
- Voltage or current input
- Adjustable relay setpoint, hysteresis and activation delay
- Input signal management (loss of signal)
- Displays input voltage or current
- LED status indication of each relay
- Snap Track mounting
- Non-strip, raising clam terminals

Model	Relays
CVC002	2
CVC004	4



## SCC80: Changeover Control Sensor

- 24Vac or 24 Vdc supply
- Sensor operation temperature up to 80°C [176°F]
- Fast response, excellent accuracy
- SPDT output relay
- No adjustments required (pre-calibrated)
- Built-in mounting tabs and mounting screws supplied for easy installation
- Status LED



Comes with male/female collar

Total connector pressure output is routed behind probe to minimize pressure loss and noise

Bullet shaped averaging chamber for low pressure loss and noise

3/16" Static pressure signal amplification ring

Equal area total pressure port

Static pressure connector output routed behind probe to minimize loss and noise

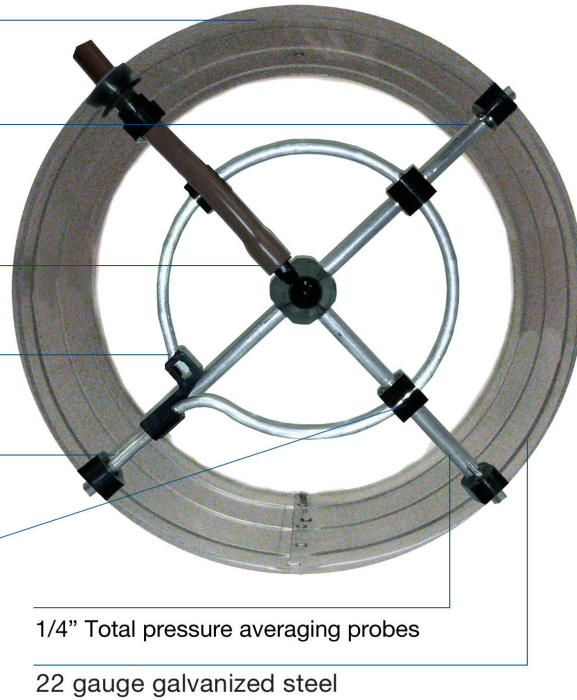

## Air Flow Stations

Mechanically amplifies the differential pressure signal making air velocity measurement in VAV boxes possible.

## Main Features

- Mechanical amplification of differential pressure signal
- 2 outputs (total pressure and static pressure)
- Advanced design minimizes pressure loss and white noise

## Models

Description	CF-06	CF-08	CF-10	CF-12	CF-14	CF-16
Inlet Diameter	6" (15.25 cm)	8" (20.30 cm)	10" (25.40 cm)	12" (30.50 cm)	14" (35.56 cm)	16" (40.64 cm)
Area	0.196 ft <sup>2</sup> (0.018 m <sup>2</sup> )	0.349 ft <sup>2</sup> (0.032 m <sup>2</sup> )	0.545 ft <sup>2</sup> (0.050 m <sup>2</sup> )	0.785 ft <sup>2</sup> (0.073 m <sup>2</sup> )	1.069 ft <sup>2</sup> (0.099 m <sup>2</sup> )	1.396 ft <sup>2</sup> (0.130 m <sup>2</sup> )
Velocity Constant	2812 FPM (14.3 m/s)	2740 FPM (13.9 m/s)	2841 FPM (14.4 m/s)	2822 FPM (14.3 m/s)	2666 FPM (13.5 m/s)	2837 FPM (14.4 m/s)
Velocity Pressure Constant	0.49	0.47	0.50	0.49	0.45	0.50
K Factor	552 CFM (261 l/s)	956 CFM (451 l/s)	1550 CFM (732 l/s)	2216 CFM (1046 l/s)	2850 CFM (1345 l/s)	3961 CFM (1869 l/s)
Amplification Factor F	2.60	2.30	2.30	2.15	2.15	2.10
Total Pressure Ports (ASHRAE Standard 62)	12	12	16	16	20	20
Velocity Range	300 to 3,000 FPM (1.5 to 15.2 m/s)					
Temperature Range	-40°C to 80°C (-40°F to 176°F)					
Materials	Aluminum & PC/ABS					



## ACTUATORS

Up to 70in.lb  
(8Nm)



**D-B-S**

- 35in.lb (4Nm) to 70in.lb (8Nm)

Up to 360in.lb  
(40Nm)



**L-T-R**

- 140in.lb (16Nm) to 360in.lb (40Nm)

Up to 4000in.lb  
(450Nm)

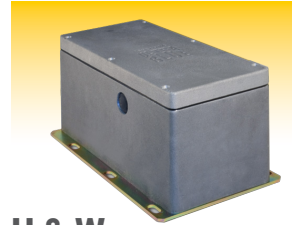

**U & W**

- 1800in.lb (200Nm) to 4000in.lb (450Nm)

Fast



**B-T-R**

- Running time of 1.5sec to 30sec

**Smoke Damper**

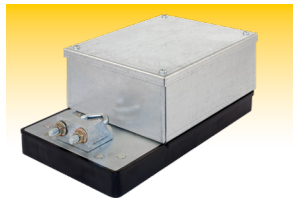

**BTX-LX**

- Rated at 250°F (121°C)

**Outdoor**



**IP65**

- High humidity and outdoor applications

**Linear**



**A-V-X**

- Zone, globe and PIC valve applications

## ACTUATED VALVES

**Characterized Ball**



**Contoured Port Ball**



**Full Port Ball**



**Industrial Ball**

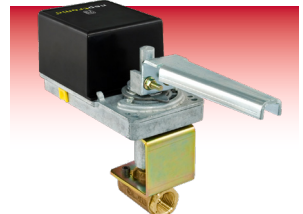

**Butterfly**



**Zone**



**Globe**





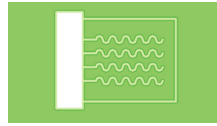

## HECB Networkable Controller



### BENEFITS

#### Save Energy

- Embedded and configurable energy conservation strategies
- Automatic or dynamic load shedding
- Limit electric heater consumption based on multiple variables
- Provides real-time temperature measures and power consumption data

#### Save Time

- View heater status and alarms remotely via network or thermostat
- Remote monitoring (status, alarms, diagnostics, and trending)
- Wall-mount remote user interface (view temperature, setpoint, heater status and alarms)

#### Integrate

- Integrate with BMS and intelligent buildings via BACnet MS/TP or Modbus
- Multiple BACnet/Modbus points to propel you towards the Internet of Things (IoT)
- Ensure better management of energy consumption for the future

#### Standard Features

- Accepts any industry standard input signal
- Quick and simple input signal selection via DIP switches
- Modulating, on/off, and/or up to 10 stages
- Real-time feedback output of heater capacity
- Automatic PID
- Remote feedback with TDU LCD thermostat (eliminates the use of expensive staged thermostats)
- Zero voltage crossing SSR
- Patented EAS Electronic Air Flow Sensors (US 7,012,223)

#### Network Communication

- BACnet MS/TP or Modbus RTU (selectable via DIP switch)
- Select MAC address via DIP switch or via network

#### BACnet MS/TP

- MS/TP @9600, 19200, 38400 or 76800 bps
- BACnet scheduler (up to 6 events)
- Firmware upgradeable via network
- COV (change of value)
- Copy and broadcast configuration to other HECB controllers via menu or network
- Automatic baud rate detection
- Automatic device instance configuration

#### Modbus RTU

- Modbus RTU @9600, 19200, 38400 or 57600 bps
- RTU Slave, 8 bits (configurable parity and stop bits)
- Connects to any Modbus RTU master

MANUFACTURER OF 

-  HVAC CONTROLS
-  ELECTRIC ACTUATORS
-  ACTUATED VALVES
-  HUMIDIFIERS
-  ELECTRIC HEATERS

  
**neptronic.com**